



20 August 2010

**Nassau University Medical Center
Interior Sign System
Campus Wayfinding & Emergency
*Bid Document Set***



ENVIRONMENTAL GRAPHICS
Gamble Design LLC
154 Maplewood Avenue
Portsmouth NH 03801
☎ 603.427.1300

INTERIOR DESIGN/PEER REVIEW
TRO Jung | Brannen
22 Boston Wharf Road
Boston MA 02210
☎ 617.502.3400

ARCHITECTURE
CANNONDESIGN
360 Madison Avenue
New York NY 10017
☎ 212.972.9800

PAGE ID

DRAWING TITLE



EID./RID Hospital Entrance/Reception

Includes: Patient/Visitor Entrances, Reception Desks and other specialty graphics

- WID.1** Welcome ID @ Carman Avenue Entrance
- RID.1** Information ID @ Tower Elevator Lobby
- RID.2** NUMC ID @ Emergency Lobby
- RID.3** Reception ID @ Emergency Lobby



A. Identification

Includes: Department ID's, Nurse Station ID's, Room ID's (large & small), Stair ID's

- A1.1** Specialty Department ID graphics
- A2.1** Primary Department ID overhead/fascia mounted panel
- A3.1** Department ID/Listing insert armature wall mounted
- A4.1** Primary Department ID standard extrusion wall mounted
- A5.1** Secondary Department/Area ID standard extrusion wall mounted
- A6.1** Room ID standard extrusion w/Braille & tactile wall mounted
- A6.2** Room ID standard extrusion w/Braille & tactile wall mounted
- A7.1** Restroom ID panel door mounted
- A7.2** Restroom ID tactile panel wall mounted
- A7.3** Flagmounted Restroom ID 8.5" x 8.5" wall mounted
- A8.1** Stair ID standard extrusion wall mounted outside stairwell
- A8.2** Level ID standard extrusion wall mounted inside stairwell
- A8.3** Flagmounted Stair ID 6" x 6" wall mounted
- A9.1** Office ID standard extrusion with insert wall mounted
- A10.1** Utility ID standard extrusion door mounted
- A11.1** Nurse Station ID ceiling suspended 10" x 10" wall mounted
- A12.1** Exam ID flagmounted 8.5" x 8.5" wall mounted
- A13.1** Telephone/Vending ID flagmounted 6" x 6" wall mounted
- A14.1** Room ID Tag door frame mounted

PAGE ID

DRAWING TITLE



B. Information

Includes: Directories, Changeable Information Armatures (freestanding, wall mounted & desk mounted)

- B1.1** Primary Building Directory static hospital directory w/changeable graphics
- B2.1** Freestanding B2 moveable armature with insert
- B3.1** Changeable Armature (2 x) 10.5"w x 16.5"h Patient Rights/Information inserts wall mounted
- B4.1** Changeable Armature 10.5"w x 16.5"h Event/Activity/Schedule/Info insert wall mounted
- B5.1** Changeable Armature (2 x) 8.5"w x 11"h Event/Activity/Schedule/Info inserts wall mounted
- B6.1** Changeable Armature 8.5"w x 11"h Event/Activity/Schedule/Info insert wall mounted
- B7.1** Changeable Armature 8.5"w x 11"h Event/Activity/Schedule/Info insert desk mounted
- B8.1** Changeable Armature (4 x) 8.5"w x 11"h Event/Activity/Schedule/Info inserts wall mounted
- B9.1** Notifier Clip/Bar temporary information wall/door mounted



C. Regulatory

Includes: Regulatory and restrictive information and posting (Caution, Attention, Warning, Staff ONLY)

- C1.1** Primary Restriction double door or overhead panel
- C2.1** Secondary Restriction single door
- C3.1** Secondary Restriction wall mounted
- C4.1** Room Slider enter/do not enter graphics door mounted
- C5.1** Staff ONLY restricted door/wall mounted
- C6.1** General Info miscellaneous information (scan badge, push button, etc) wall/door mounted
- C7.1** No Smoking/Tobacco Free wall mounted
- C8.1** Fragrance Free wall/desk mounted
- C9.1** Door Graphics automatic/sliding door graphics
- C10.1** Radioactive Material door graphics
- C11.1** Biohazard door graphics



PAGE ID DRAWING TITLE



D. Directional

Includes: Overhead & wall mounted directional signs

- D1.1 Primary Overhead** fascia mounted/ceiling suspended
- D2.1 Double Directional (wall)** 2'-6"H x 3'-0 1/4"W wall mounted
- D3.1 Single Directional (wall)** 2'-6"H x 1'-6"W wall mounted
- D4.1 Tertiary Changeable (wall)** 11 3/4"H x 11 3/4"W (Refer to drawing Aint. 1)



E. Elevator

Includes: Directionals, overhead & wall mounted

- E1.1 Primary Elevator ID** projecting at elevators
- E2.1 Secondary Elevator ID** dimensional letters wall mounted
- E3.1 Elevator ID/Directional** single armature with elevator/level information
- E4.1 Patient Confidentiality** interior elevator wall mounted



F. Fire/Safety

Includes: Fire Extinguisher/Code required graphics

- F1.1 Fire Extinguisher/Eyewash ID** flagmounted
- F2.1 TTY Telephone ID** desk mounted/freestanding
- F3.1 NFPA Stair ID** inside stairwell wall mounted
- F4.1 Fire Control/Safety Signs** room ID wall/door mounted (NOTE: layouts as required)
- F5.1 Fire Door ID** sign panel door mounted

IG. Installation Guides

Includes: Install heights and locations for standard sign types

- IG.1-6 Installation Guidelines 1-6** standard mounting heights and locations

KEY:

Sign Location Plan: sign locator graphic



Drawing Title "Code": variations used in drawing sets

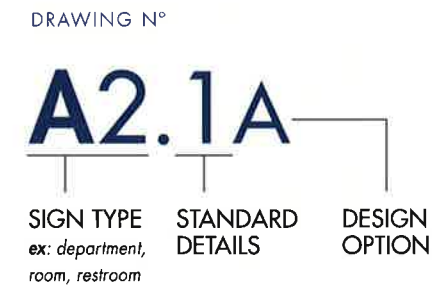

Standard Design Identification



Sign Panel

1/2" painted "Deep Blue Metallic" MP#25373 panel with "Satin Aluminum" MP#18071 accent identity band; Panel mounts to wall above entry door in precise alignment with architectural conditions as shown. Conceal all fasteners. Field verify all conditions.

Graphics

1/8" dimensional graphics flush mount directly to face of sign panel. Paint "Satin Aluminum" MP#18071 (Nassau...), "Medium Gray Metallic" MP#46638 (Welcome to) & to match NuHealth logo colors (Pantone 3005U "Bright Blue" MP#13912 & 312U)

WID Welcome ID fascia mounted panel @ Carman Avenue Entrance
 1 Scale: 3" = 1'-0"



INTERIOR SIGN SYSTEM NASSAU UNIVERSITY MEDICAL CENTER



ENVIRONMENTAL GRAPHICS
Gamble Design LLC
 154 Maplewood Avenue
 Portsmouth NH 03801
 ☎ 603.427.1300

INTERIOR DESIGN
TRO Jung|Brannen
 22 Boston Wharf Road
 Boston MA 02210
 ☎ 617.502.3400

DRAWING TITLE
Welcome ID @ Carman Ave.
 Fascia mounted panel
 Scale: 3" = 1'-0"
 20 August 2010

DRAWING N°

WID.1



Existing

Overhead Sign Panel:

Overhead sign panel (single-sided) consists of painted 3/4" "Extira" substrate or equal mounts to existing columns with concealed mounting hardware. "Satin Aluminum" MP#18071 & "Dark Blue Metallic" MP#25373 panel. Finish/band all edges; Back side painted "Satin Aluminum" Field verify all conditions. Mounting method to be determined in coordination with Owner re: asbestos in ceiling. (Note: replacing existing ceiling mounted sign.)

Graphics

1/8" dimensional graphics flush mount directly to face of sign panel. Paint "Satin Aluminum" MP#18071 (Nassau...), "Medium Gray Metallic" MP#46638 (Welcome to) & to match NuHealth logo colors (Pantone 3005U "Bright Blue" MP#13912 & 312U)

WID 2 Welcome ID suspended panel @ Level G lobby
Scale: relative to image



INTERIOR SIGN SYSTEM NASSAU UNIVERSITY MEDICAL CENTER



ENVIRONMENTAL GRAPHICS
Gamble Design LLC
154 Maplewood Avenue
Portsmouth NH 03801
☎ 603.427.1300

INTERIOR DESIGN
TRO Jung|Brannen
22 Boston Wharf Road
Boston MA 02210
☎ 617.502.3400

DRAWING TITLE
Welcome ID @ Level G
Suspended panel
Scale: as shown
20 August 2010

DRAWING N°
WID.2

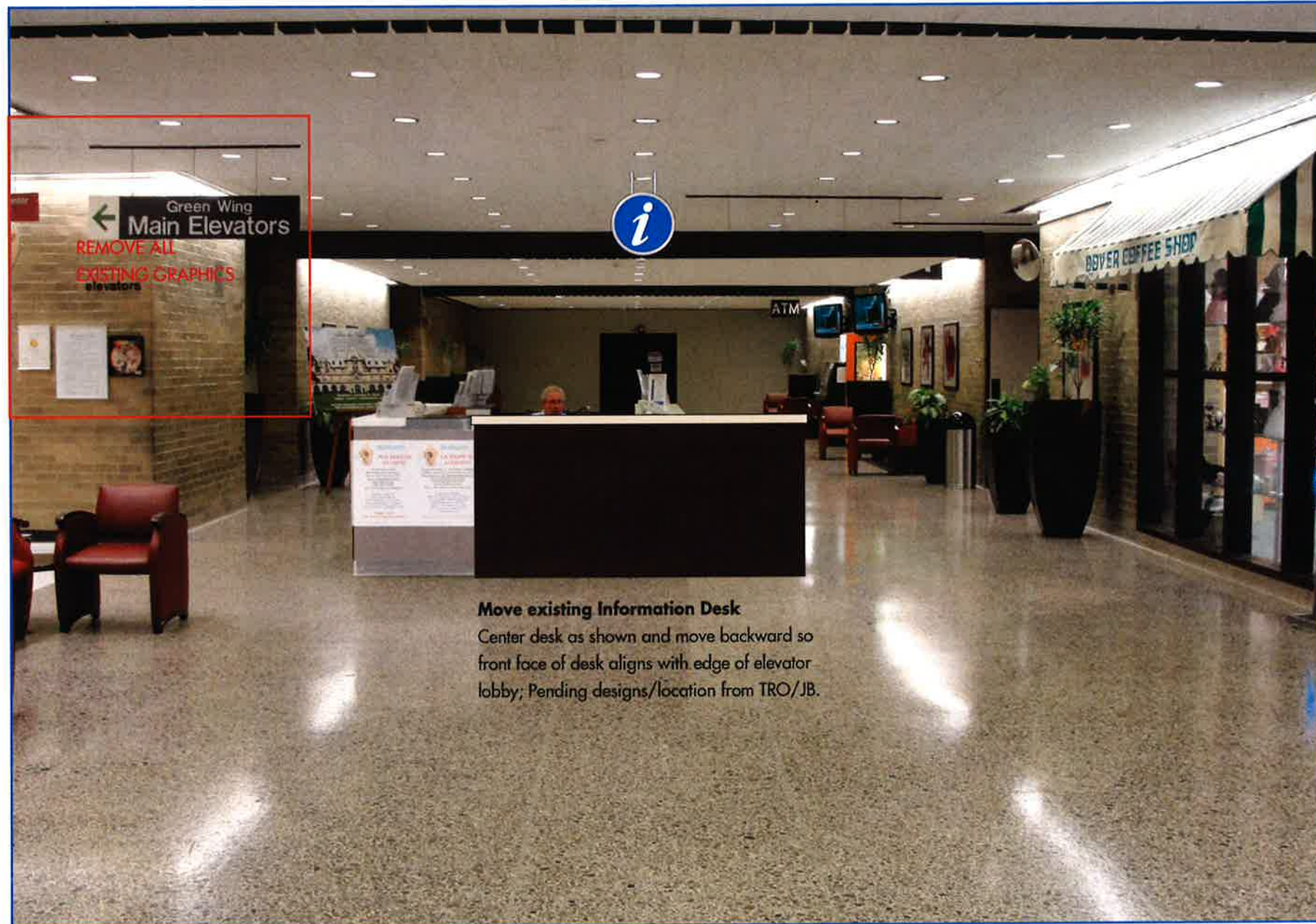

Move existing Information Desk
Center desk as shown and move backward so front face of desk aligns with edge of elevator lobby; Pending designs/location from TRO/JB.

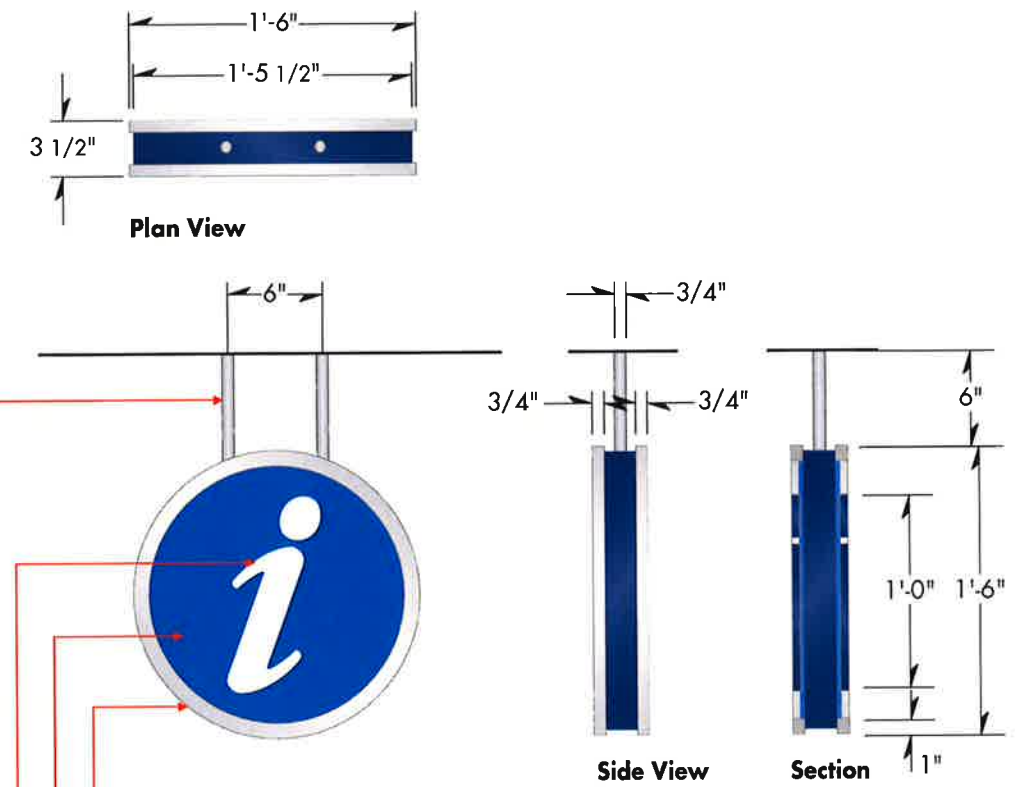

Frame

"Satin Aluminum" MP#18071 frame in dimensions shown with "Dark Blue Metallic" MP#25373 accent recessed 1/4" on all sides; Frame holds interior sign face.

Sign Face

Interior disk recessed 1/2" from edge of frame; Paint "Bright Blue" MP#13912 (Soda Can Blue)

Graphics

1/2" dimensional "White" MP#32071 "i" flush mounted to sign face.

Mounting

3/4" diameter "Satin Aluminum" post mounts disk to ceiling. Center disk over desk (existing desk to move, coordinate with Owner). Field verify all conditions. Coordinate with Owner re: ceiling mounted sign/asbestos.

RID 1 Information Desk ID ceiling suspended
Scale: relative to image

A Information Desk ID double-sided ceiling suspended
Scale: 1" = 1'-0"

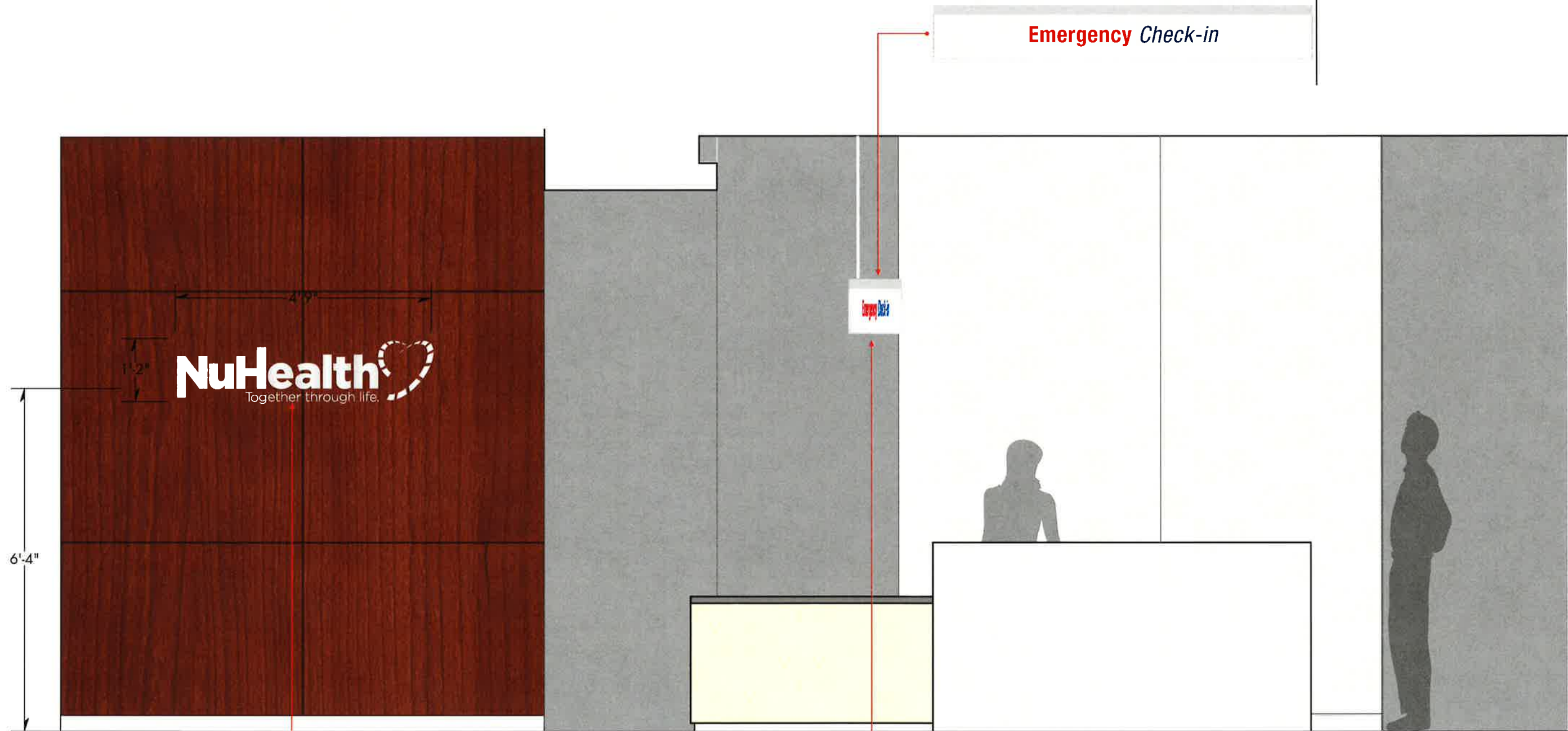

NuHealth ID

1/2" thick dimensional "Satin Aluminum" laser cut graphics pin mount to wall panels at Emergency entrance. Pin-mounted graphics with 1/4" stand-offs. Stud mounted to wall panel. Paint "Satin Aluminum" MP#18071; Center on panels as shown.

Reception ID

Refer to document RID.3 for details

RID 2 NuHealth ID dimensional graphics wall mounted
Scale: 1/2" = 1'-0"



INTERIOR SIGN SYSTEM NASSAU UNIVERSITY MEDICAL CENTER



ENVIRONMENTAL GRAPHICS
Gamble Design LLC
154 Maplewood Avenue
Portsmouth NH 03801
603.427.1300

INTERIOR DESIGN
TRO Jung | Brannen
22 Boston Wharf Road
Boston MA 02210
617.502.3400

DRAWING TITLE
NuHealth ID
Wall mounted
Scale: as shown
20 August 2010

DRAWING N°

RID.2

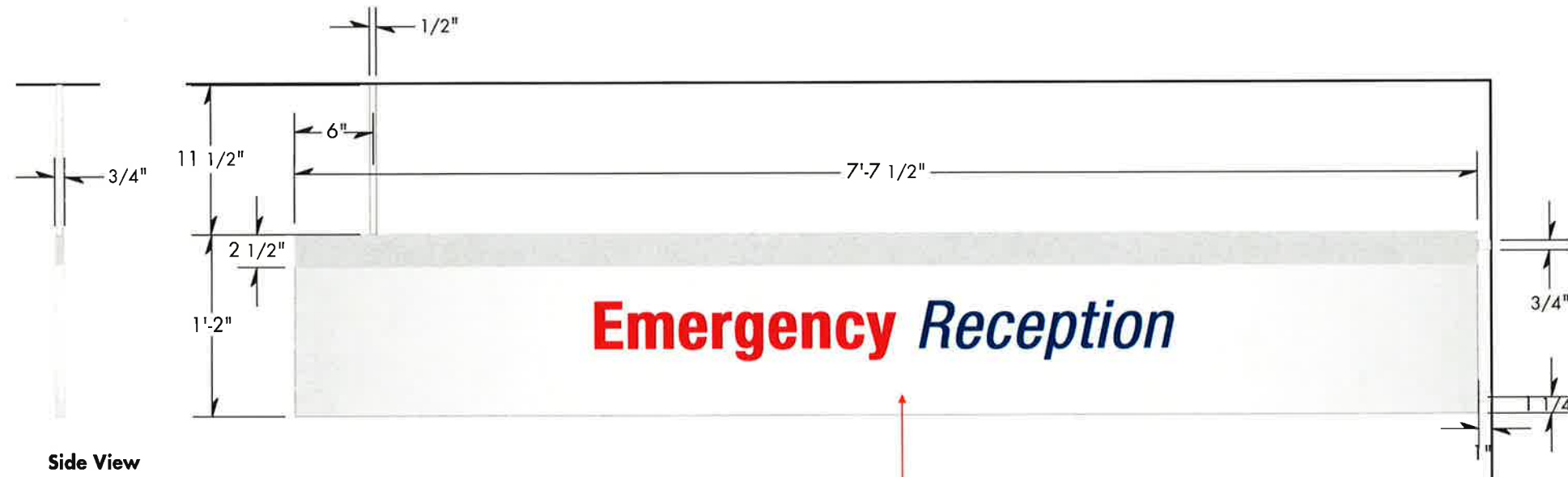
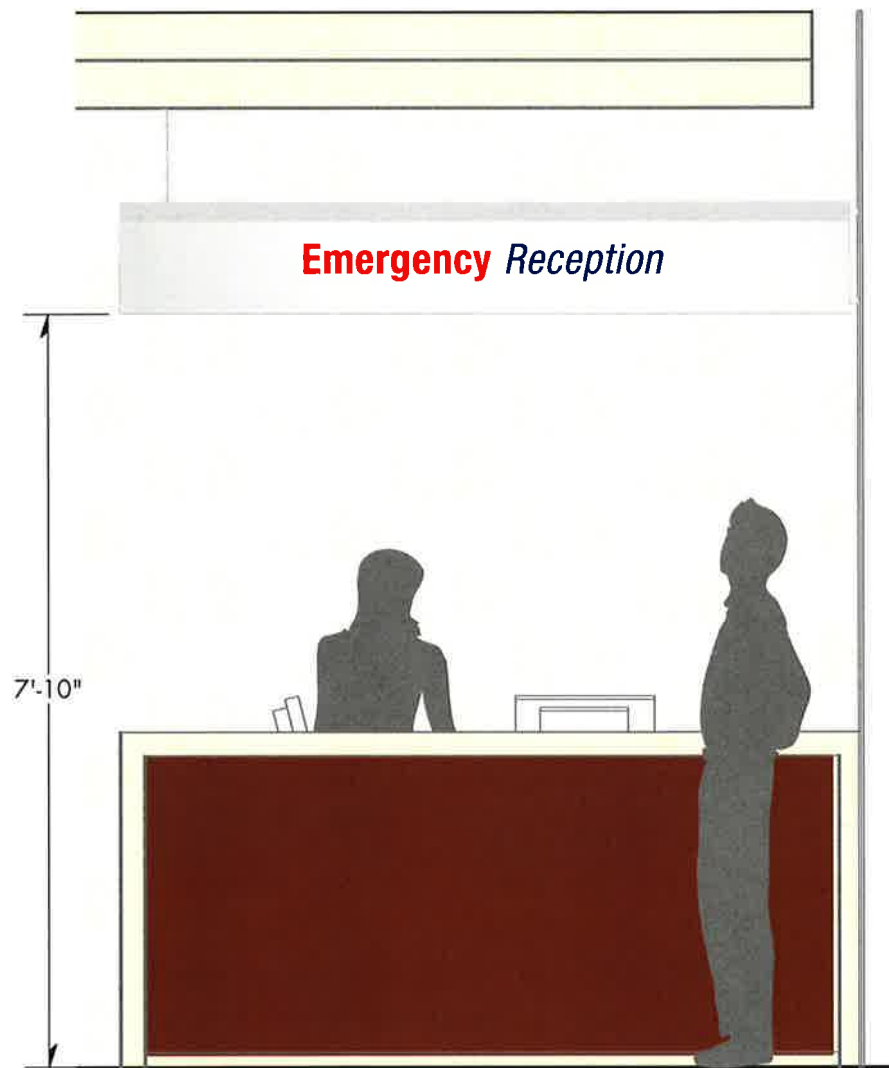

Overhead Sign Panel:

Overhead sign panel (single-sided) consists of painted 3/4" "Extira" substrate or equal with concealed mounting hardware to ACT/other ceiling above. Band/finish all edges. "Satin Aluminum" MP#18071 panel with "Medium Gray Metallic" MP#46638 accent band @ top of sign panel; 1/8" dimensional graphics painted "Red" & "Dark Blue Metallic" MP#25373. 1/2" diameter "Satin Aluminum" mounting posts suspend from ceiling and "Satin Aluminum" bracket/post mount to wall as shown. Conceal all fasteners on sign face; Field verify all conditions.

RID 3 Emergency Reception ID sign panel projecting/suspended
Scale: 1/2" = 1'-0"

A Emergency Reception ID sign panel projecting/suspended
Scale: 1" = 1'-0"



INTERIOR SIGN SYSTEM NASSAU UNIVERSITY MEDICAL CENTER



ENVIRONMENTAL GRAPHICS
Gamble Design LLC
154 Maplewood Avenue
Portsmouth NH 03801
603.427.1300

INTERIOR DESIGN
TRO Jung | Brannen
22 Boston Wharf Road
Boston MA 02210
617.502.3400

DRAWING TITLE
Emergency Reception ID overhead
Projecting/suspended
Scale: as shown
20 August 2010

DRAWING N°

RID.3



Option Sign panel suspended from columns

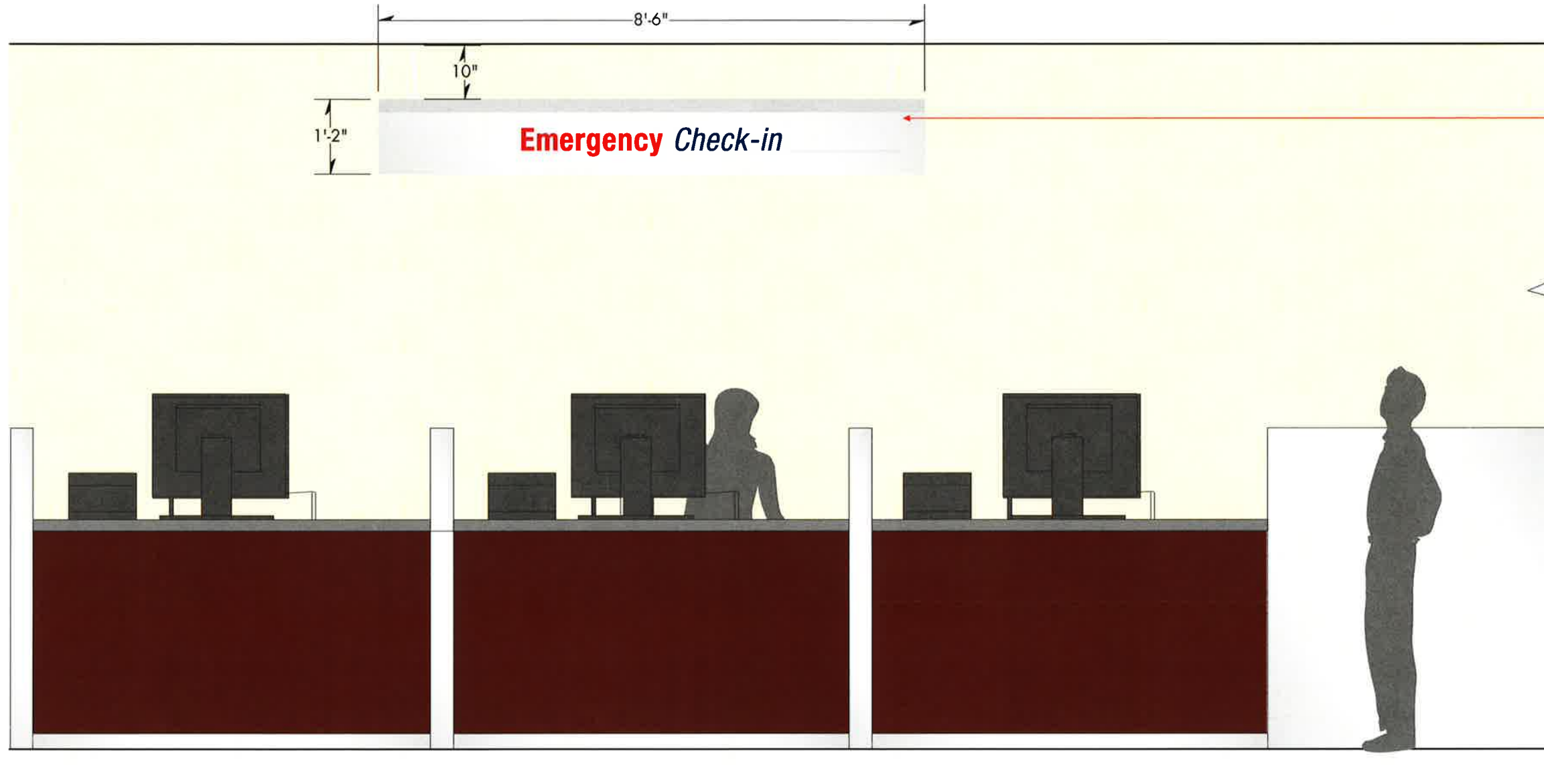

Overhead Directional Sign:

Overhead sign panel (single-sided) consists of painted 3/4" "Exira" substrate or equal with concealed mounting hardware to ACT/other ceiling above (Option: suspended across corridor from bracket arms so to not penetrate ceiling). Band/finish all edges. "Satin Aluminum" panel with "Medium Gray Metallic" accent band @ top of sign panel; 1/8" dimensional graphics painted "Red" & "Dark Blue Metallic". 1/2" diameter posts secure to ceiling. Field verify all conditions.

Paint colors:

- A) "Medium Gray Metallic" MP#46638
- B) "Satin Aluminum" MP#18071
- C) "Dark Blue Metallic" MP#25373
- D) "Red" MP# _____

RID 4 Emergency Reception ID single-sided *suspended*
Scale: 1/2" = 1'-0"

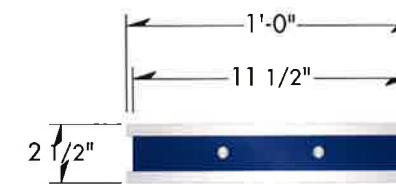
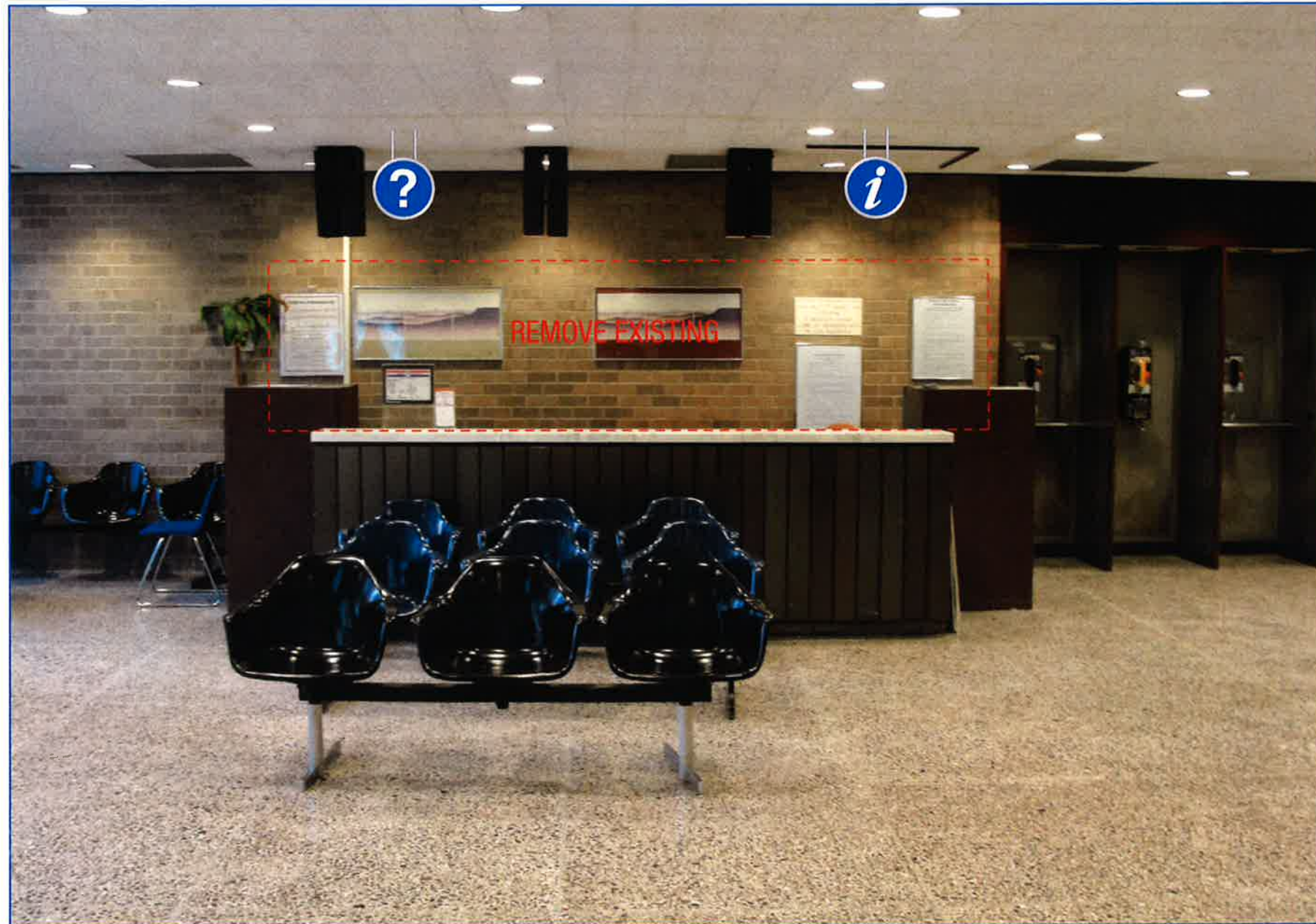

Plan View

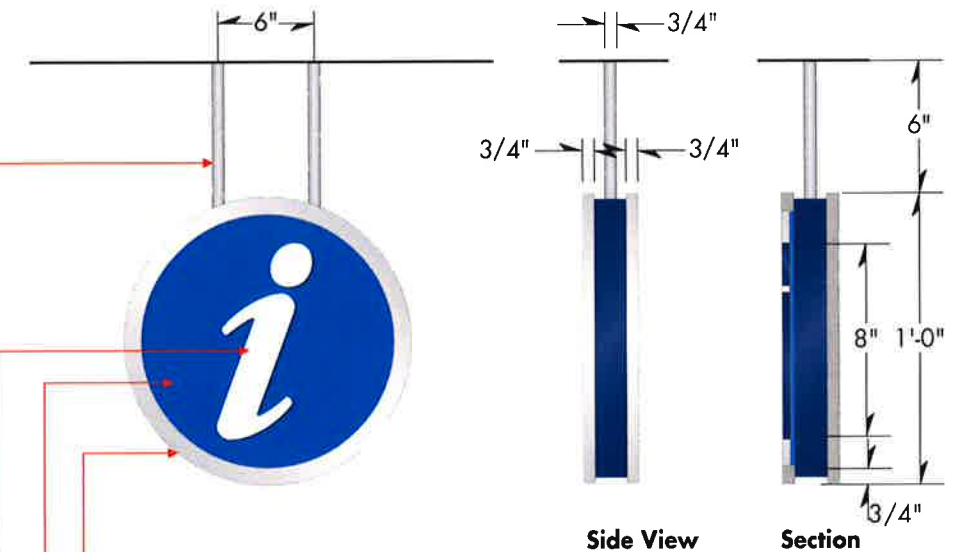

Side View

Section

Frame

"Satin Aluminum" MP#18071 frame n dimensions shown with "Dark Blue Metallic" MP#25373 accent recessed 1/4" on all sides; Frame holds interior sign face.

Sign Face

Interior disk recessed 1/2" from edge of frame; Paint "Bright Blue" MP#13912 (Soda Can Blue)

Graphics

1/2" dimensional "White" MP#32071 "i" & "?" flush mounted to sign face.

Mounting

1/2" diameter "Satin Aluminum" post mounts disk to existing ceiling in locations shown. Field verify all conditions. Coordinate with Owner re: ceiling mounted sign/asbestos.

Qty: 2 (two) as shown

RID 5 Information Desk ID Level G Lobby ceiling suspended
Scale: relative to image

A Information Desk ID single-sided ceiling suspended
Scale: 1 1/2" = 1'-0"



Option Sign panel suspended from columns



Overhead Directional Sign:

Overhead sign panel (single-sided) consists of painted 3/4" "Extira" substrate or equal with concealed mounting hardware to ACT/other ceiling above (Option: suspended across desk from bracket/post to avoid ceiling penetration). Band/finish all edges. "Satin Aluminum" panel with "Medium Gray Metallic" accent band @ top of sign panel; 1/8" dimensional graphics painted "Dark Blue Metallic". 1/2" diameter mounting posts mount to ceiling. Field verify all conditions.

Paint colors:

- A) "Medium Gray Metallic" MP#46638
- B) "Satin Aluminum" MP#18071
- C) "Dark Blue Metallic" MP#25373

RID 6 Women's Center ID Level 1 Women's Center Lobby suspended
Scale: relative to image



INTERIOR SIGN SYSTEM NASSAU UNIVERSITY MEDICAL CENTER



ENVIRONMENTAL GRAPHICS
Gamble Design LLC
154 Maplewood Avenue
Portsmouth NH 03801
603.427.1300

INTERIOR DESIGN
TRO Jung | Brannen
22 Boston Wharf Road
Boston MA 02210
617.502.3400

DRAWING TITLE
Women's Center ID Overhead
Suspended
Scale: as shown
20 August 2010

DRAWING N°

RID.6

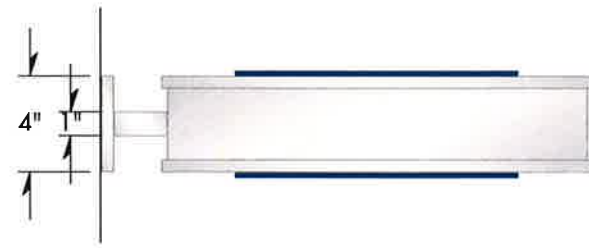

Plan View

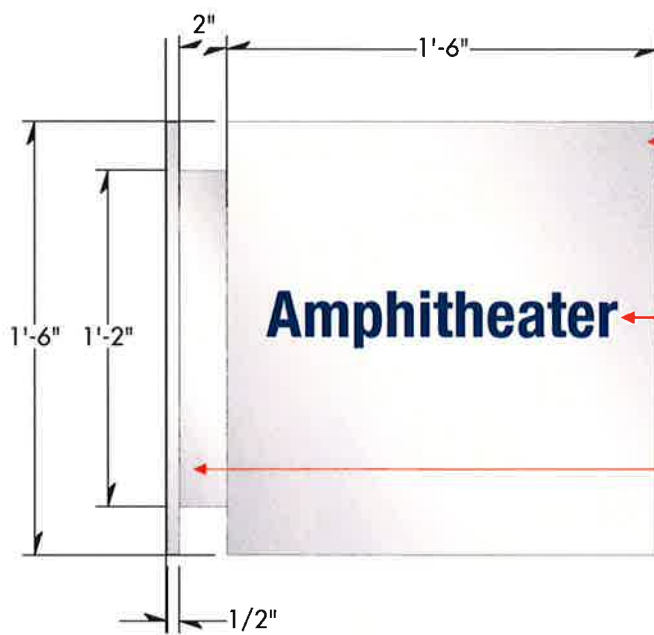

Sign Box
4" deep projecting sign box painted "Satin Aluminum" MP#18071 with 1/2" face panels and 3" recessed "Satin Aluminum" sign box.

Graphics
1/8" dimensional elevator graphics painted "Deep Blue Metallic" MP#25373

Mounting Armature
1" "Satin Aluminum" mounting armature projects from sign box with 1/2" thick mounting plate. Plate secures to wall with concealed or decorative fasteners. (Fabricator to detail connection in shop drawings.) Field verify all conditions.

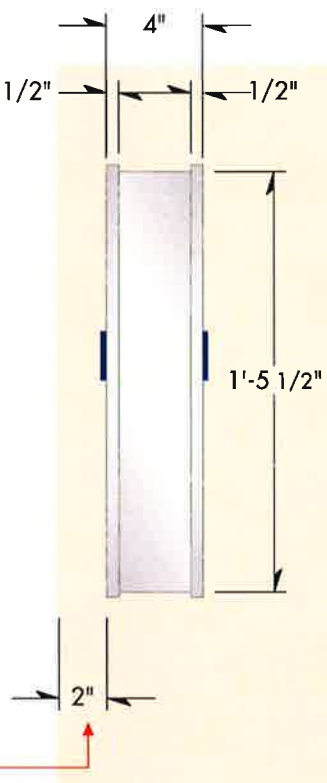

Mounting
Sign assembly mounts as shown in image. Inset sign assembly 2" from corner and 1 brick down from ceiling. Assembly mounts to outside corners of entry. (example: left entry = to left of door/right entry = to right of door)

Qty : 2 (two)
1 @ each entry

A1 Amphitheater ID Level 1
1 Scale: relative to image

A Amphitheater ID double-sided projecting
Scale: 1 1/2" = 1'-0"

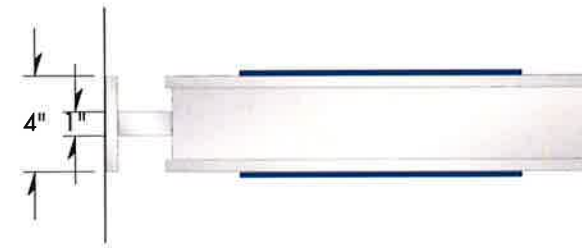

Plan View

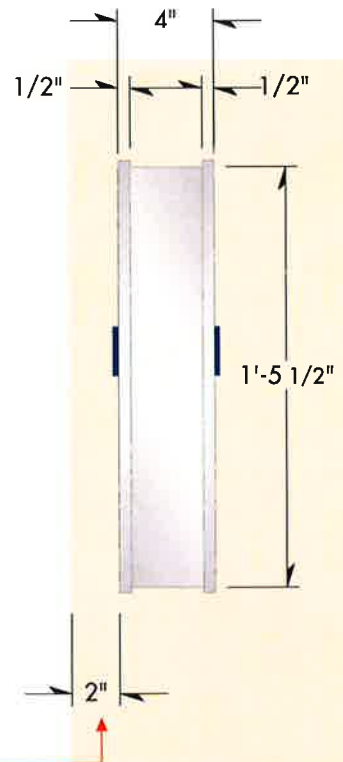
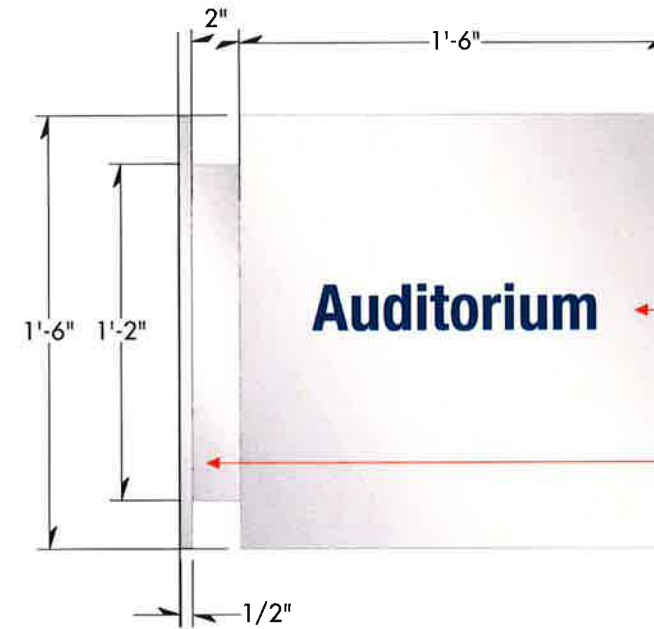

Sign Box

4" deep projecting sign box painted "Satin Aluminum" MP#18071 with 1/2" face panels and 3" recessed "Satin Aluminum" sign box.

Graphics

1/8" dimensional elevator graphics painted "Deep Blue Metallic" MP#25373

Mounting Armature

1" "Satin Aluminum" mounting armature projects from sign box with 1/2" thick mounting plate. Plate secures to wall with concealed or decorative fasteners. (Fabricator to detail connection in shop drawings.) Field verify all conditions.

Mounting

Sign assembly mounts as shown in image. Inset sign assembly 2" from corner and 1 brick down from ceiling. Assembly mounts to outside corners of entry. (example: left entry = to left of door/right entry = to right of door)

Qty : 2 (two)

1 @ each entry

A1 Auditorium ID Level 1
1 Scale: relative to image

A Auditorium ID double-sided projecting
Scale: 1 1/2" = 1'-0"

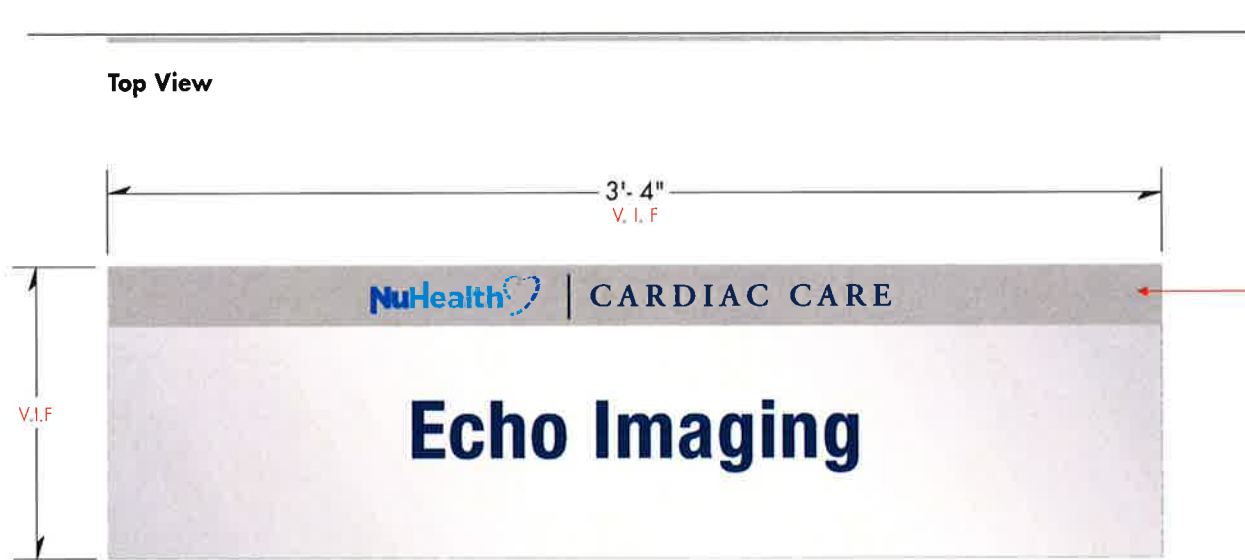

Overhead Department ID

1/4" panel painted "Satin Aluminum" MP#18071 with "Medium Gray Metallic" band MP#46638 and vinyl graphics in colors shown; Mounted to overhead fascia in precise alignment with architectural conditions; Mount with adhesive or concealed fasteners *as required*. Verify all dimensions/conditions.

Vinyl colors:

- Dark Blue Metallic 3M#220-217
- Matte Blue 3M#220-407
- Olympic Blue 3M#220-57

Quantities/Sign Sizes:

For pricing purposes, please price the following size signs

8'-0" x 1'-0" = 2 (two)/single-sided fascia mounted

6'-0" x 10" = 4 (four)/single-sided fascia mounted

4'-6" x 10" = 2 (two)/single-sided fascia mounted

3'-6" x 10" = 39 (thirty-nine)/single-sided fascia mounted

A2 Overhead Department ID Echo Imaging typical entry door

1 Scale: relative to image

A Overhead Department ID Elevation typical

Scale: 1 1/2" = 1'-0"



INTERIOR SIGN SYSTEM NASSAU UNIVERSITY MEDICAL CENTER



ENVIRONMENTAL GRAPHICS
Gamble Design LLC
 154 Maplewood Avenue
 Portsmouth NH 03801
 ☎ 603.427.1300

INTERIOR DESIGN
TRO Jung|Brannen
 22 Boston Wharf Road
 Boston MA 02210
 ☎ 617.502.3400

DRAWING TITLE
Overhead Department ID
 Fascia mounted
 Scale: as shown
 20 August 2010

DRAWING N°

A2.1

Top View



Overhead Department ID

1/4" panel painted "Satin Aluminum" MP#18071 with "Medium Gray Metallic" band MP#46638 and vinyl graphics in colors shown; Mounted to overhead fascia in precise alignment with architectural conditions; Mount with adhesive or concealed fasteners as required. Verify all dimensions/conditions.

Vinyl colors:

Dark Blue Metallic 3M#220-217

Matte Blue 3M#220-407

Olympic Blue 3M#220-57

Quantities/Sign Sizes:

Please refer to list on page A2.1 for sizes.

A2 Department ID fascia mounted
1 Scale: 1" = 1'-0"



INTERIOR SIGN SYSTEM NASSAU UNIVERSITY MEDICAL CENTER



ENVIRONMENTAL GRAPHICS
Gamble Design LLC
154 Maplewood Avenue
Portsmouth NH 03801
603.427.1300

INTERIOR DESIGN
TRO Jung | Brannen
22 Boston Wharf Road
Boston MA 02210
617.502.3400

DRAWING TITLE
Department ID Overhead
Fascia mounted
Scale: as shown
20 August 2010

DRAWING N°

A2.2

Branding Band
 3/16" "Medium Gray Metallic" MP#46638 branding band with "Dark Blue Metallic" 3M#220-217 vinyl graphics; assembly mounts to extended backer panel in specified locations

Physical Medicine & Rehabilitation

Double line header

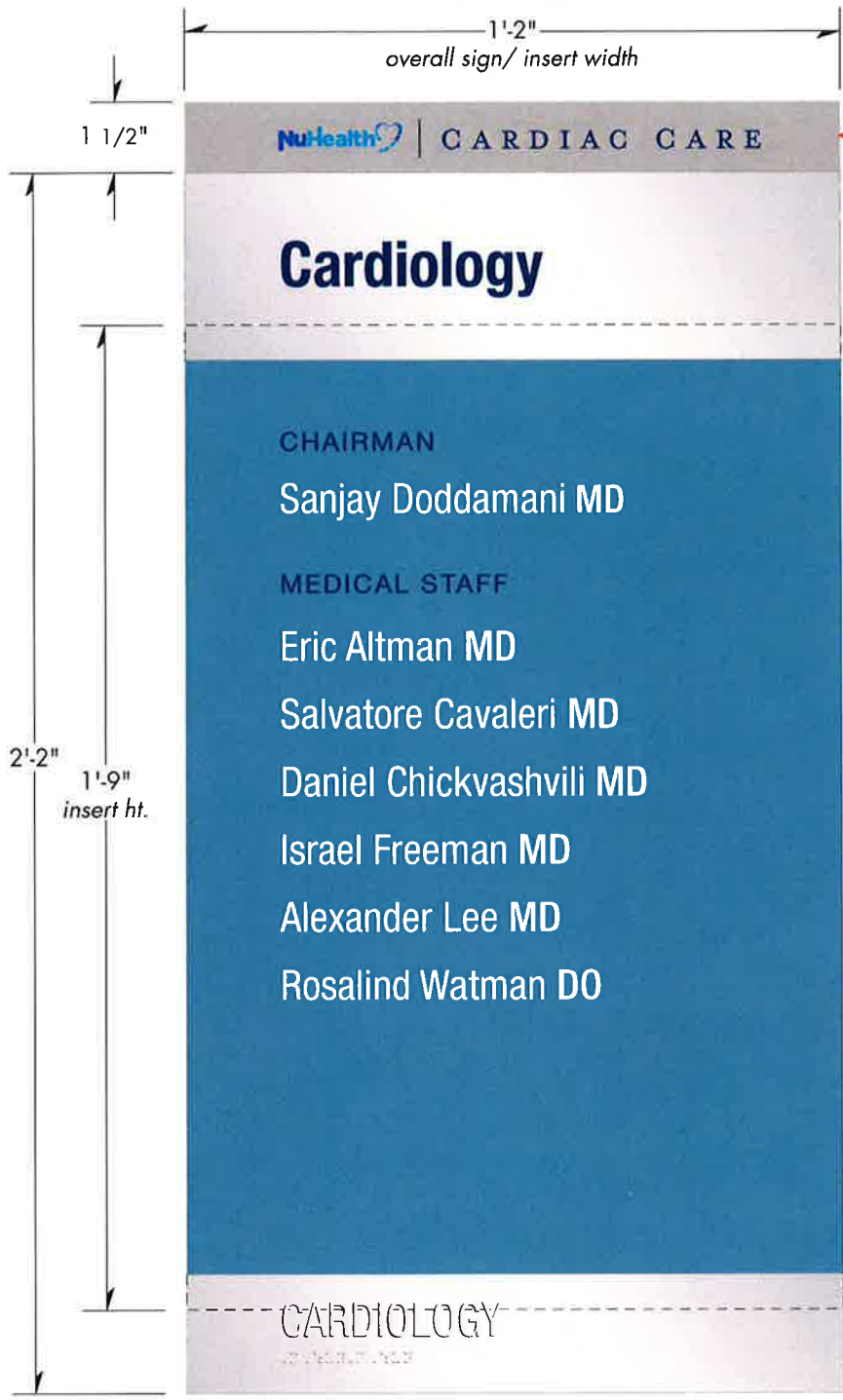

w/branding band

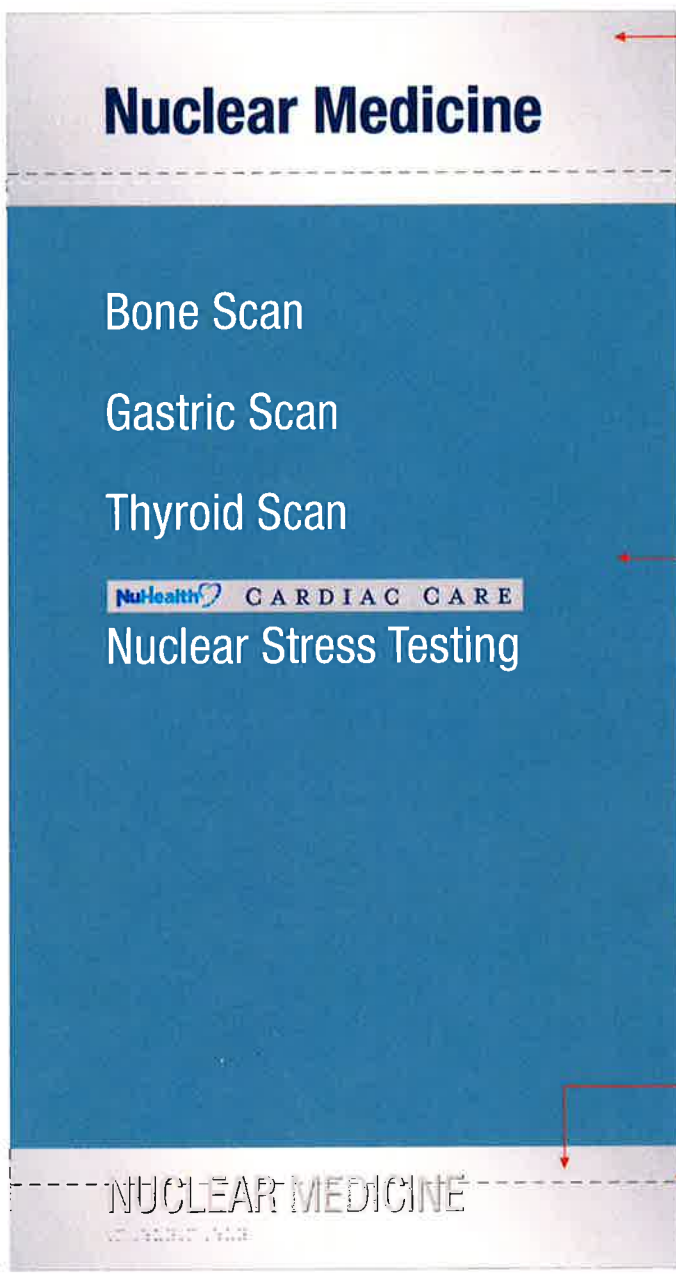

w/out branding band

Upper Band
 3/16" "Satin Aluminum" MP#18071 upper band with "Dark Blue Metallic" 3M#220-217 vinyl graphics; Mounts to backer panel with 1/16" thick foamtape or equal to accept .060" Styrene® insert; 1/16" bevel on bottom edge of accent band.
 NOTE: Placement of band must be exact so insert fits precisely within armature.

Insert extends of (dashed line)

Backer Panel
 1/8" painted "Satin Aluminum" MP#18071 backer panel inset 1/8" on both top and bottom

Changeable Graphics
 .060" Styrene® with printed graphics and Anti-Graffiti Laminate over printed graphic; NOTE: fabricator to confirm exact dimensions of insert = 1'-2" W x 1'-9" HT
 Contact @ Image 4:
 Elizabeth Hummel © 603.644.0077

Background color: **Pantone 549c**
 Printed graphics on substrate to match vinyl colors:
 White 3M#220-10
 Matte Blue 3M#220-407
 Olympic Blue 3M#220-57
 Dark Blue Metallic 3M#220-217

Insert extends of (dashed line)

Lower Band
 3/16" "Satin Aluminum" MP#18071 accent band with tactile graphics and Grade II Raster Dot Braille; Mounts to backer panel with 1/16" thick foamtape or equal to accept .060" Styrene® insert; 1/16" bevel on top edge of accent band.
 NOTE: Placement of band must be exact so insert fits precisely within armature.

Mounting
 Tactile/Grade II Braille must be mounted above 4'-0" AFF.

A3 Department ID/Listing Cardiology with "Center of Excellence" band
 Scale: 3" = 1'-0"

Department ID/Listing Nuclear Medicine
 Scale: 3" = 1'-0"

A Side Elevations
 Scale: 3" = 1'-0"

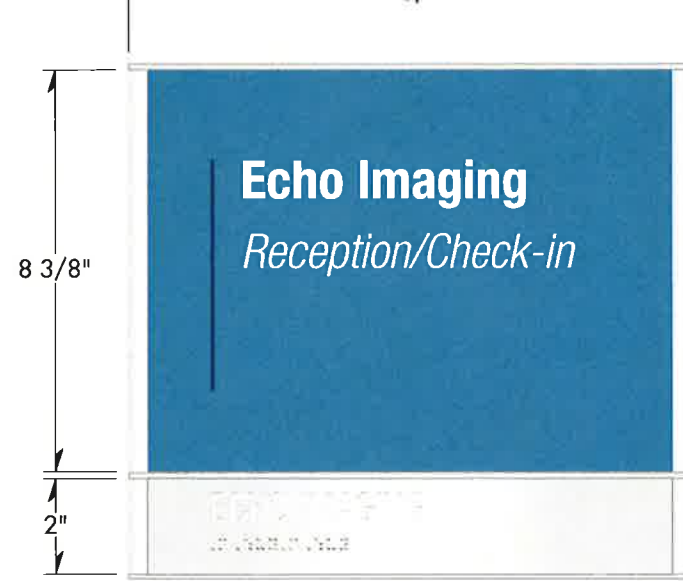

A4 Primary Department ID tactile Standard ClearPath™ extrusion with NEW top cap, printed insert and separate Braille insert by fabricator
Qty: 0 (zero)



A5 Secondary Dept/Area ID tactile Standard ClearPath™ extrusion with NEW top cap, printed insert and separate Braille insert by fabricator
Qty: 19 (nineteen)

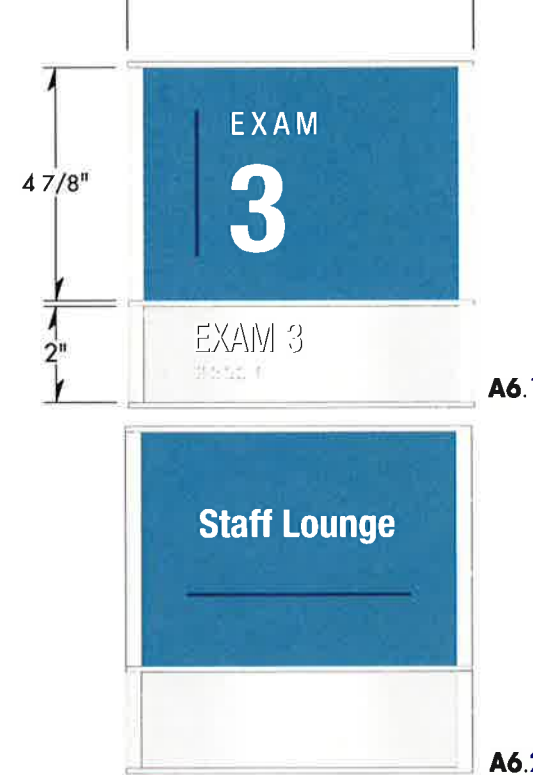

A6 Primary Room ID Standard ClearPath™ extrusion with NEW top cap, printed insert and separate Braille/tactile insert by fabricator
A6.1 Qty: 103 (one hundred and three)
A6.2 Qty: 17 (seventeen)

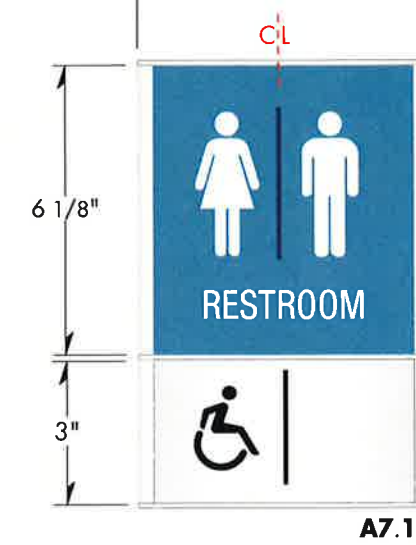

A7.1 Restroom ID door-mounted Standard ClearPath™ extrusion with NEW top cap and printed insert by fabricator
Qty: 44 (fourty-four)



A7.2 Restroom ID door-mounted Standard ClearPath™ extrusion w/NEW top cap and tactile/Grade II Braille insert by fabricator
Qty: 44 (fourty-four)

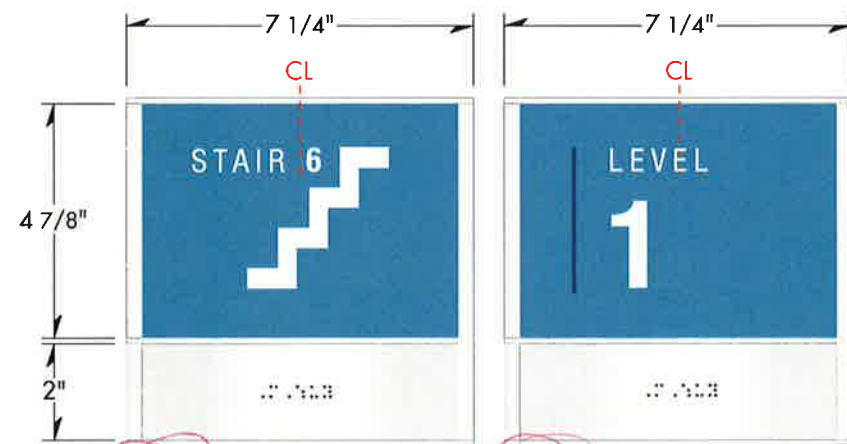

A8 Primary Room Standard ClearPath™ extrusion with NEW top cap, printed insert and separate Braille/tactile insert by fabricator
A8.1 Qty: 22 (twenty-two)
A8.2 Qty: 23 (twenty-three)

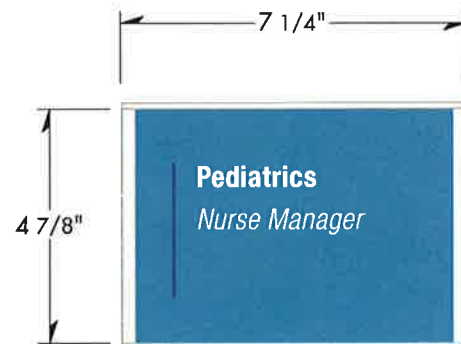

A9 Office ID Standard ClearPath™ extrusion w/NEW top cap and printed insert by fabricator
Qty: 21 (twenty-one)

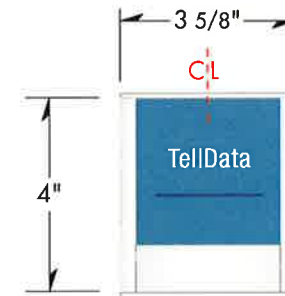

A10 Utility ID door mounted Standard ClearPath™ extrusion w/NEW top cap and printed insert by fabricator
Qty: 60 (sixty)

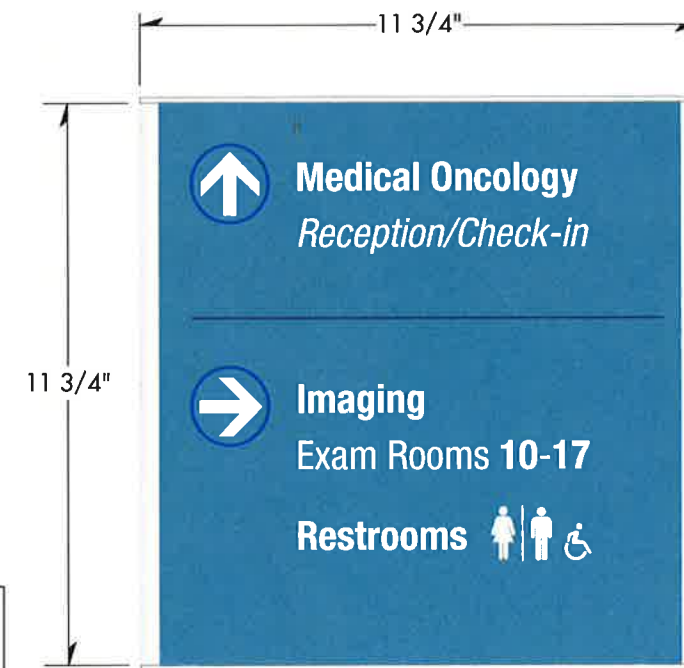

D4 Tertiary Directional Standard ClearPath™ extrusion w/NEW top cap & printed insert by fabricator
Qty: 0 (zero)

ClearPath Armature
Frame Triline/Hi-Tech with Ellipse edge treatment/silver
Profile code TLHT248E-S
Contact: Emily Cordes @ ClearPath
☎ 419.429.3864

Armature/Fabricator NOTES:

- Armature: Silver Anodize
- Lens: Clear non-glare lens
- NEW cap: To replace top cap of sign extrusion by fabricator. Provide prototype to Designer for approval.
- Tactile Braille insert by fabricator

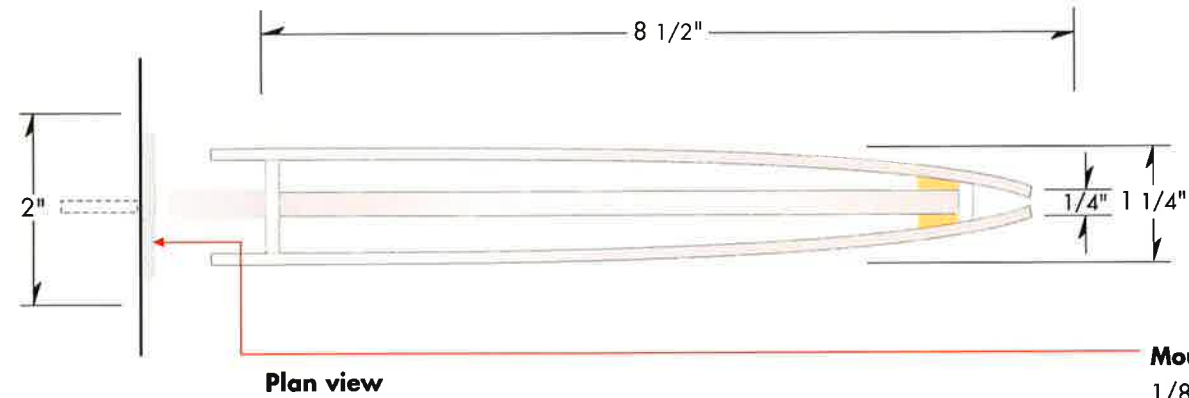

Mounting Plate

1/8" "Satin Aluminum" MP#18071 mounting plate w/ hidden fasteners; Plate secures to wall with concealed and/or decorative fasteners; paint all mounting hardware "Satin Aluminum" MP#18071; field verify all conditions

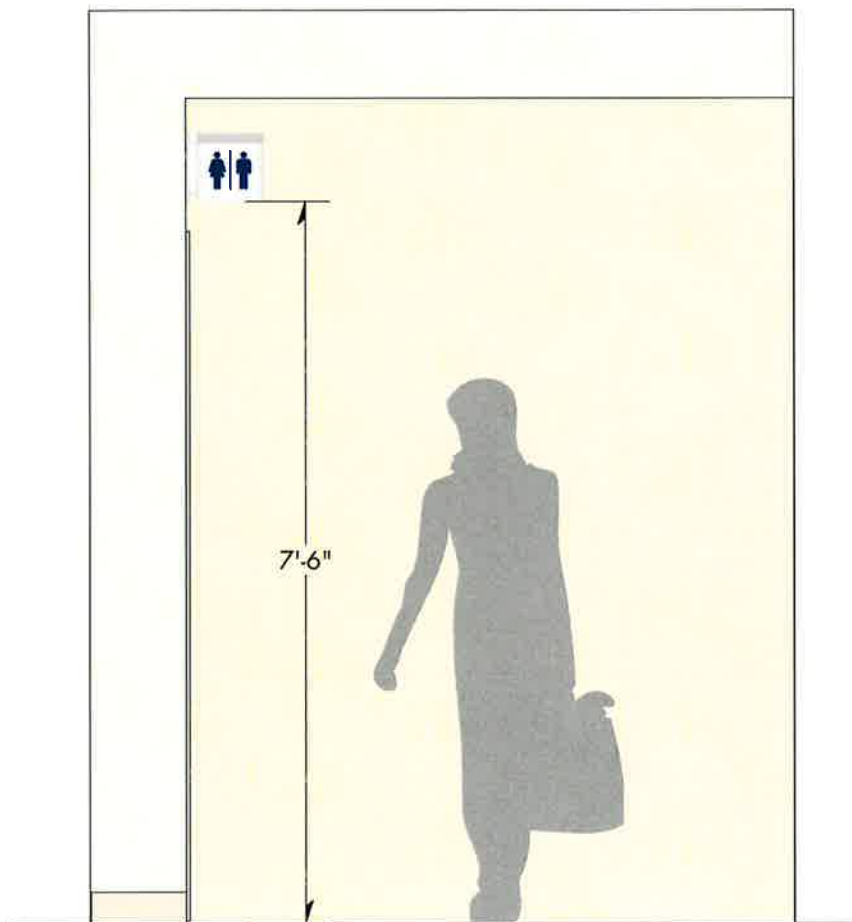

A **Flagmounted Restroom ID** double-sided *projecting*
Scale: 1/2" = 1'-0"

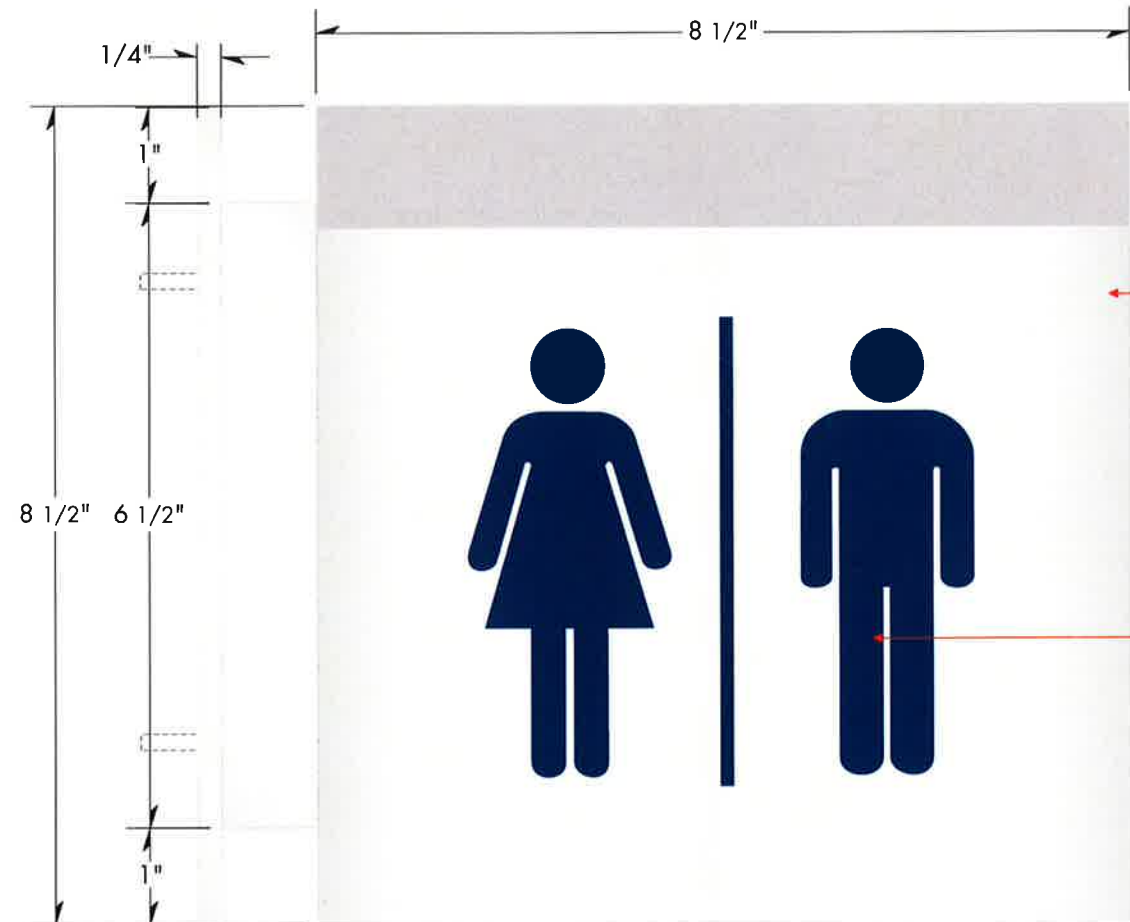

Sign Panel

Two curved, single-sided sign panels; Face(s) painted "Satin Aluminum" MP#18071 "Medium Gray Metallic" accent band MP#46638

Graphics

Vinyl graphics applied to sign face; "Dark Blue Metallic" 3M#220-217

B **Flagmounted Restroom ID** double-sided *projecting*
Scale: 1:2 half size

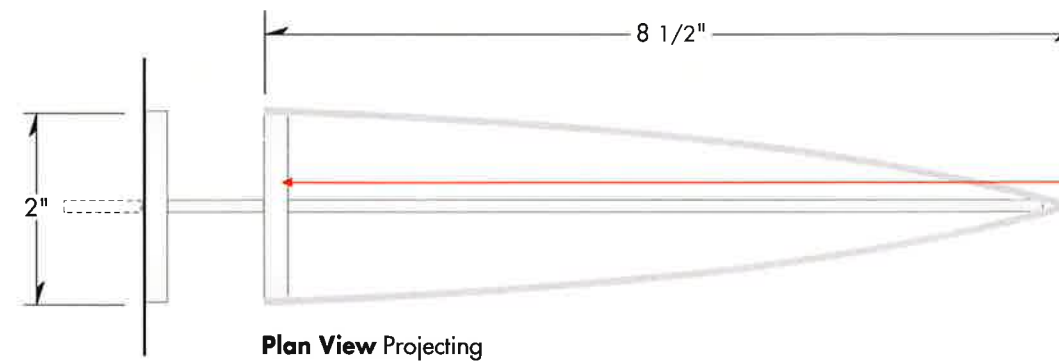

Mounting Plate
 1/4" "Satin Aluminum"
 MP#18071 mounting plate w/
 hidden fasteners projects form
 wall as required; paint all
 mounting hardware "Satin
 Aluminum" MP#18071; field
 verify all conditions

TRIAGE

1

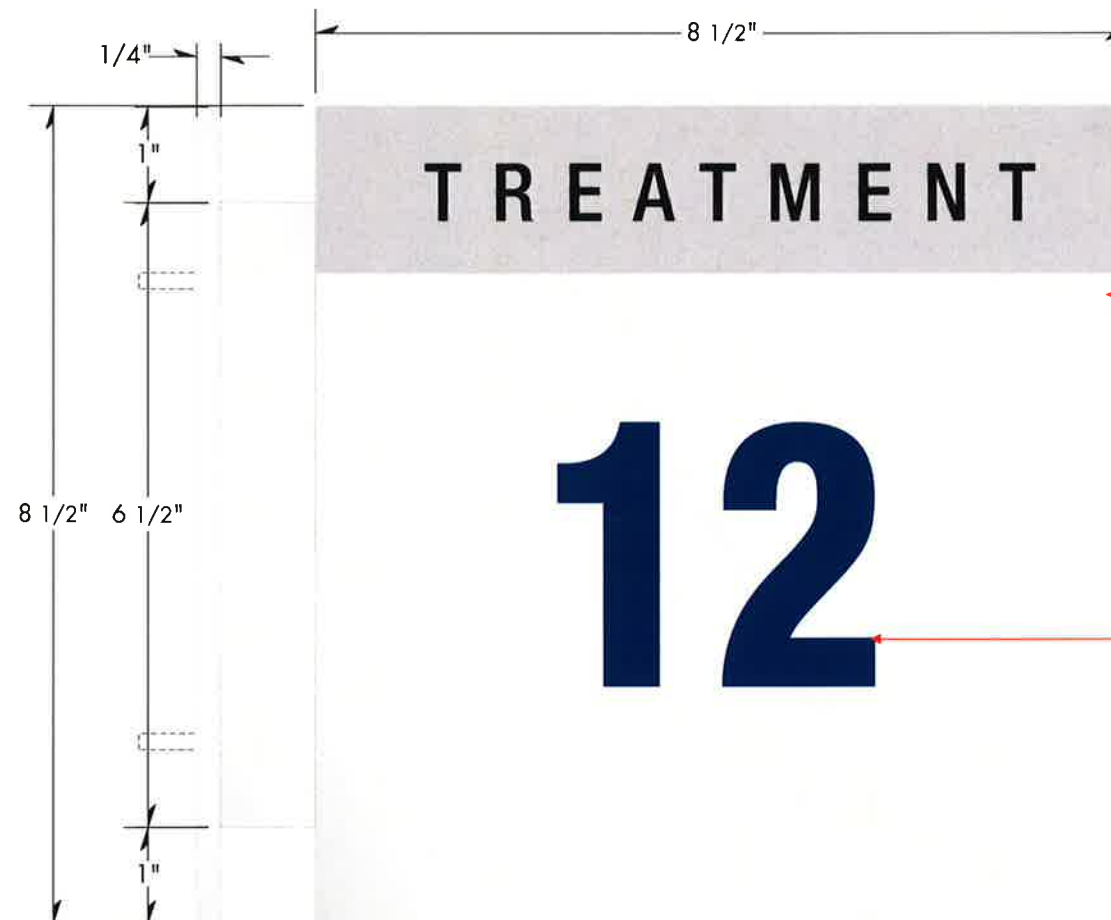

ISOLATION

15

PEDIATRIC

4

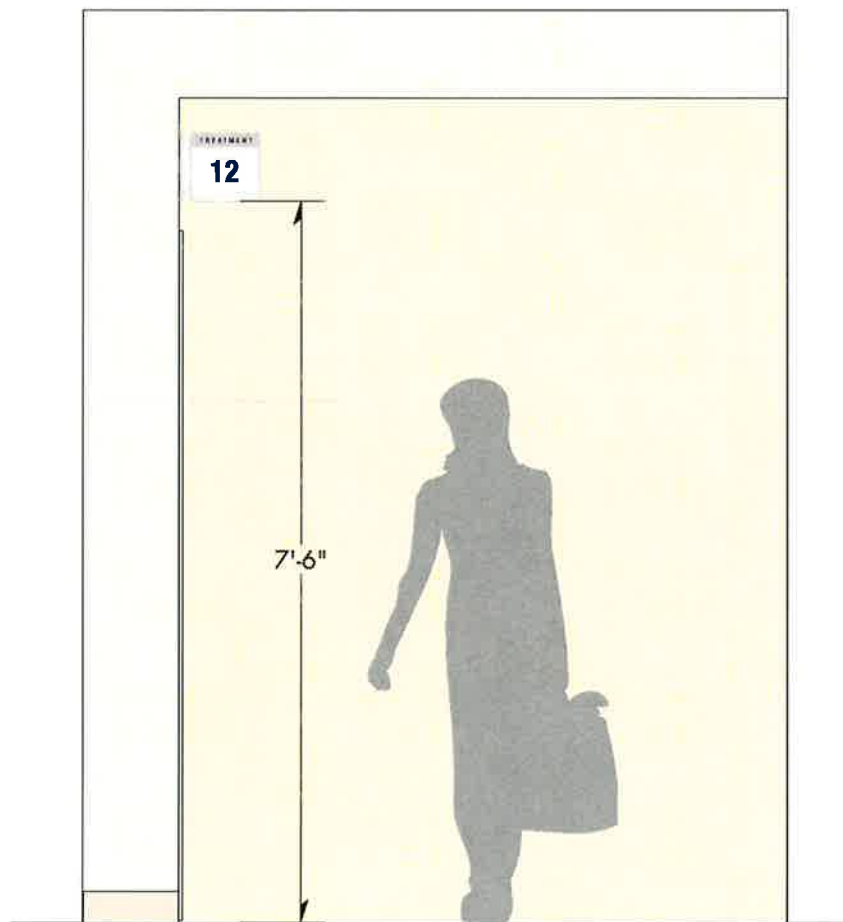

A Exam Room ID double-sided projecting
 Scale: 1/2" = 1'-0"

B Exam Room ID double-sided projecting
 Scale: 1:2 half size

Layouts typical
 Scale: 3" = 1'-0"



INTERIOR SIGN SYSTEM NASSAU UNIVERSITY MEDICAL CENTER



ENVIRONMENTAL GRAPHICS
Gamble Design LLC
 154 Maplewood Avenue
 Portsmouth NH 03801
 ☎ 603.427.1300

INTERIOR DESIGN
TRO Jung | Brannen
 22 Boston Wharf Road
 Boston MA 02210
 ☎ 617.502.3400

DRAWING TITLE
Projecting Room ID overhead
 Wall mounted
 Scale: as shown
 20 August 2010

DRAWING N°

A12.1

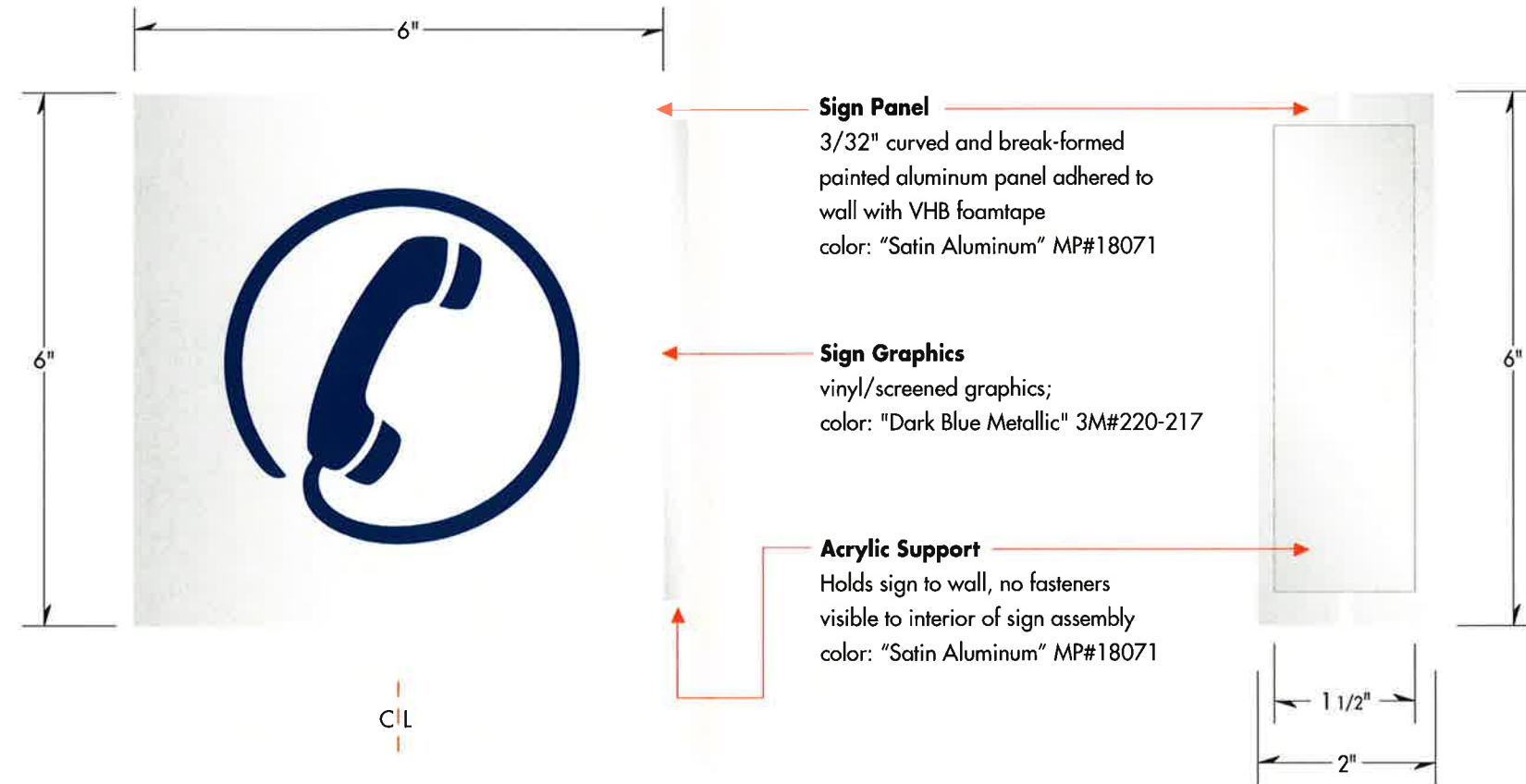
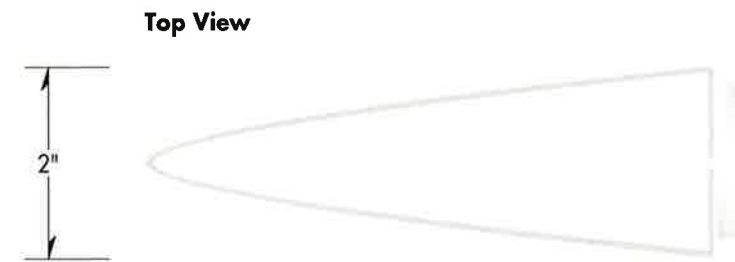

SPECIFICATION NOTES:
Fabrication: Double-sided interior curved sign fabricated per notes shown.
 Fabricator can recommend option(s) for sign fabrication.

Installation: Sign assembly projects from wall with concealed fasteners per interior architectural conditions.



A **Flagmounted Telephone ID** double-sided *projecting*
 Scale: 1/2" = 1'-0"

B **Flagmounted Vending ID** double-sided *projecting*
 Scale: 1:2 *half size*

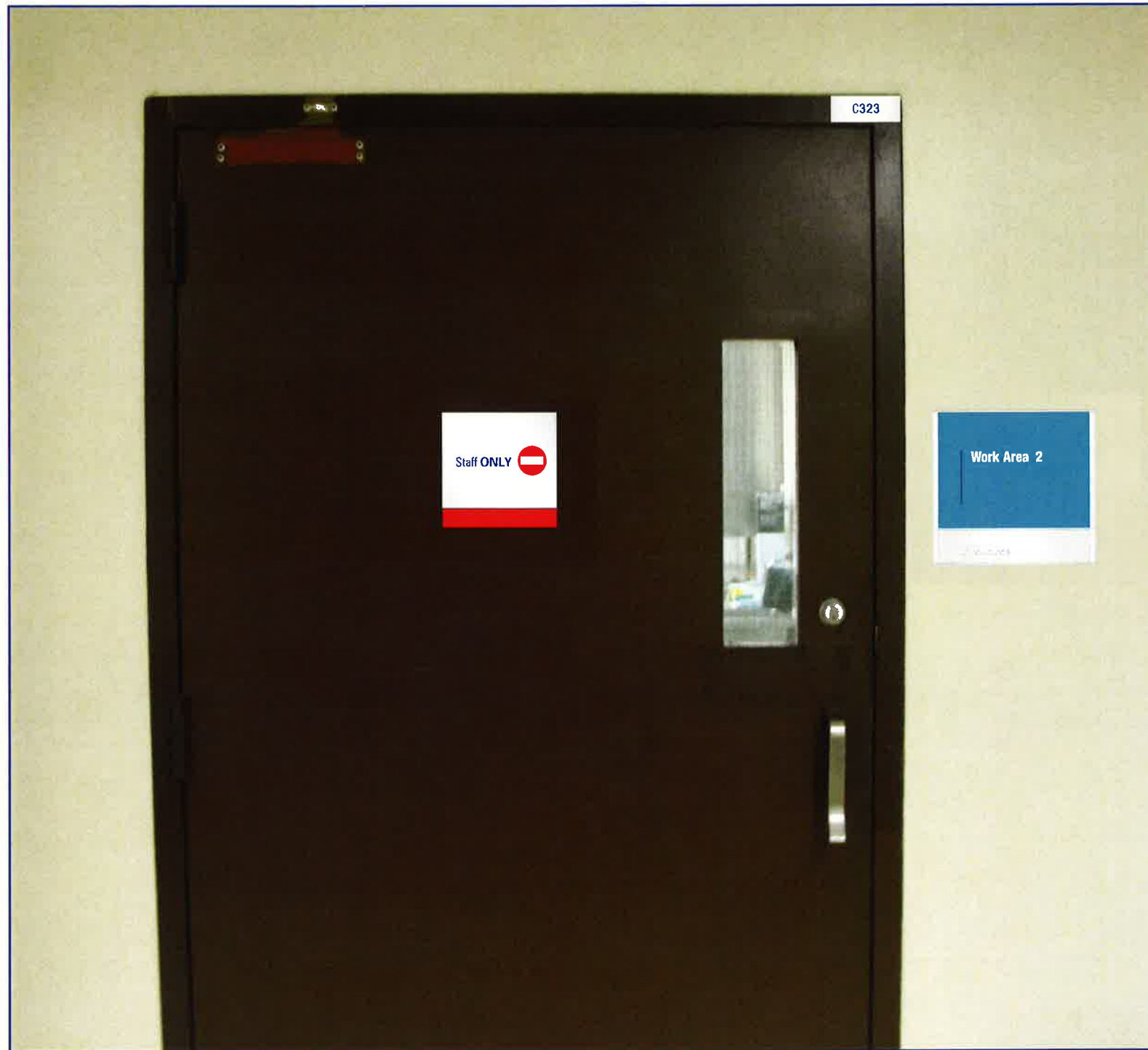

Sign Panel

1/16" "Satin Aluminum" panel, MP#18071 with applied vinyl graphics.
 "Dark Blue Metallic" MP#220-217
 Locate as shown in image.

Qty.s : 351 (three hundred fifty-one) total

ED Level G - 72 (seventy two)

ED Level 1 - 95 (ninety five)

Hospital Level G - 136 (one hundred thirty-six)

Hospital Level 1 - 52 (fifty-two)

NOTE: These signs are only located in public corridors. Owner may order additional for interior department spaces.

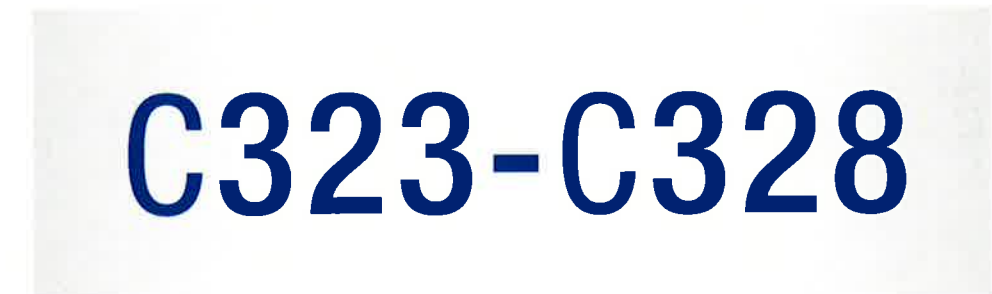

Double-lined message

A14 Room Tag ID mount to door frame
 1 Scale: relative to image

A Room Tag ID mount to door frame
 Scale: 1:1 full size

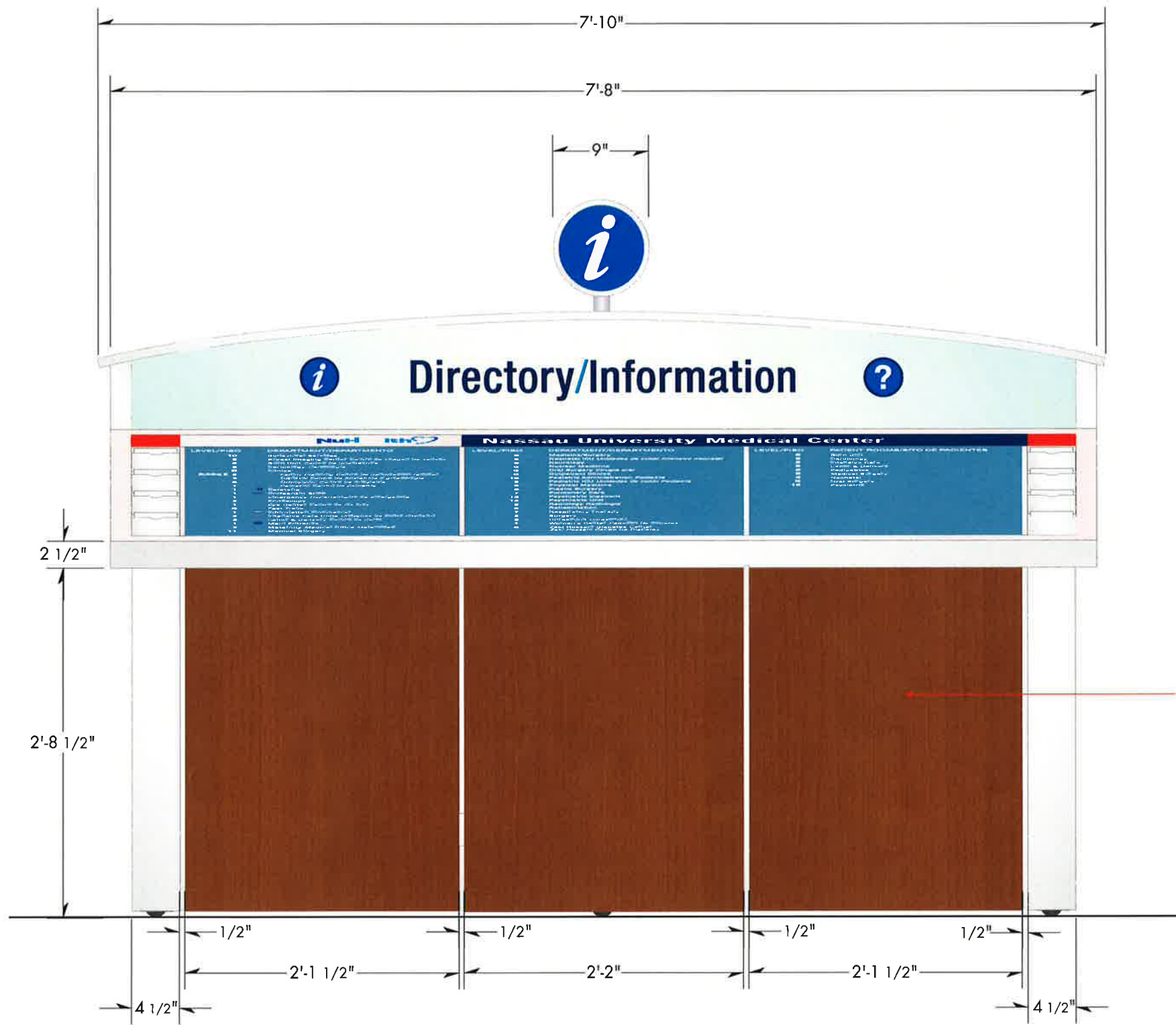

Wood Laminate typical
 Lamin-Art "Oiled Teak"
 #3050-VT
 Matte Finish

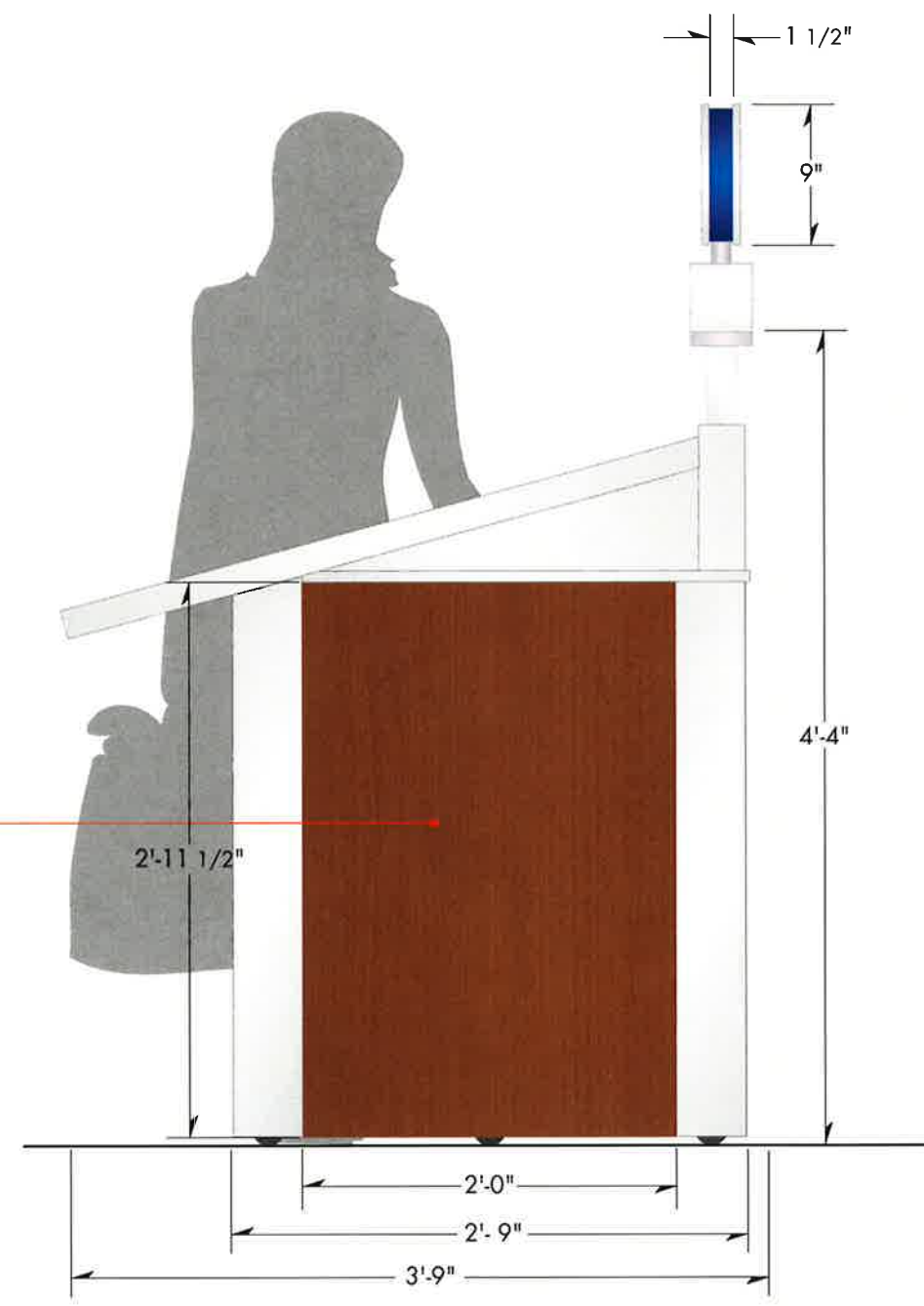

A Information Directory freestanding in main entry (Carman Avenue) corridor/Level 1 typical
 Scale: 1" = 1'-0"

B Information Directory Side Elevation typical
 Scale: 1" = 1'-0"



INTERIOR SIGN SYSTEM NASSAU UNIVERSITY MEDICAL CENTER



ENVIRONMENTAL GRAPHICS
Gamble Design LLC
 154 Maplewood Avenue
 Portsmouth NH 03801
 603.427.1300

INTERIOR DESIGN
TRO Jung|Brannen
 22 Boston Wharf Road
 Boston MA 02210
 617.502.3400

DRAWING TITLE
Information Directory
 Freestanding/changeable/movable
 Scale: as shown
 20 August 2010

DRAWING N°

B1.1

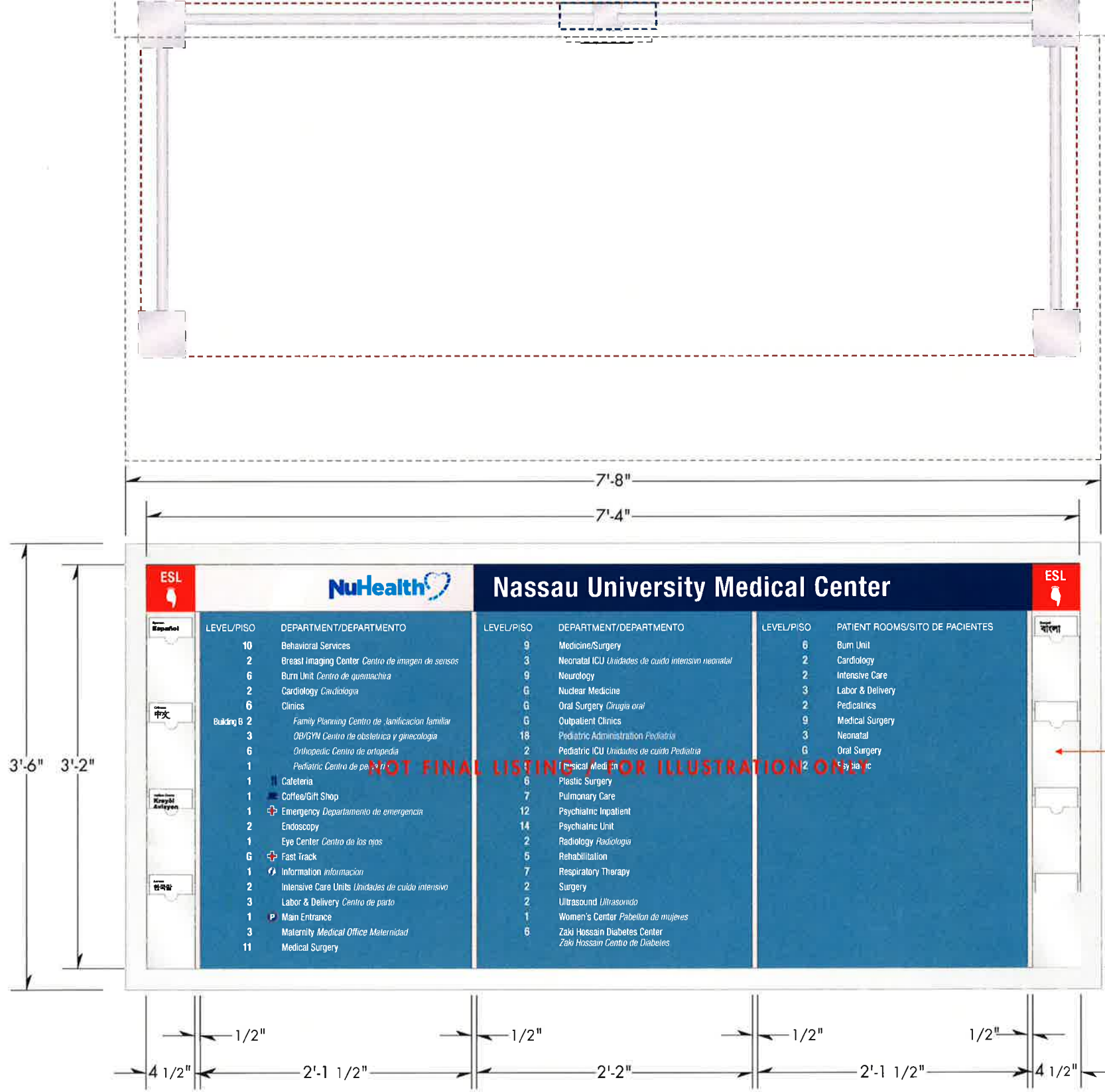

D Detail base armature
Scale: 1" = 1'-0"

C Information Directory digitally printed graphic panel inserts
Scale: 1" = 1'-0"

Directory Specifications:

Armature

2" sq. aluminum square frame assembly with wood laminate skirt in Lamin-Art "Oiled Teak" #3050-VT Matte Finish; freestanding/movable within entrance lobby; "Satin Aluminum" 2" wide L-angle frame with eased edges encompasses directory listing inserts.

Primary Departments/Destination Listing: digitally printed graphic panels insert to directory armature (changeable); insert panels placed behind satin aluminum frame and held in place by 1/2" wide removable "T" divider bar; finish to match.

Info Disk: "Satin Aluminum" outer disk has two (front & back) 1/2" wide border x 1/2" deep surrounds. Disk inset return is "Blue Metallic" (1 1/2" wide); Disk circle background is "Bright Blue" inset 1/4" on both front & back; 1/4" dimensional "i" symbol mounts flush to disk face; color: "White". Disk assembly mounted on 1 1/4" "Satin Aluminum" post.

General

All painted surfaces (and locator map) to be clear coated with Matthews Paint semi-gloss (lustre/non-gloss) protective finish to protect and seal graphics/ surfaces and compatible with special solvents used for removal of pen markings, paint, etc.

Vinyl colors:

- "White" 3M#220-10
- "Olympic Blue" 3M#220-57
- "Matte Blue" 3M#220-407

Paint colors:

- "Satin Aluminum" MP#18071
- "Blue Metallic" MP#25373

Qty: 1 (one)

Card Holder typical
Translation cards for up to eight (8) languages; accommodates up to 4" x 8 1/2" card size



Language Translation Card example

Scale: 1:2 half actual size

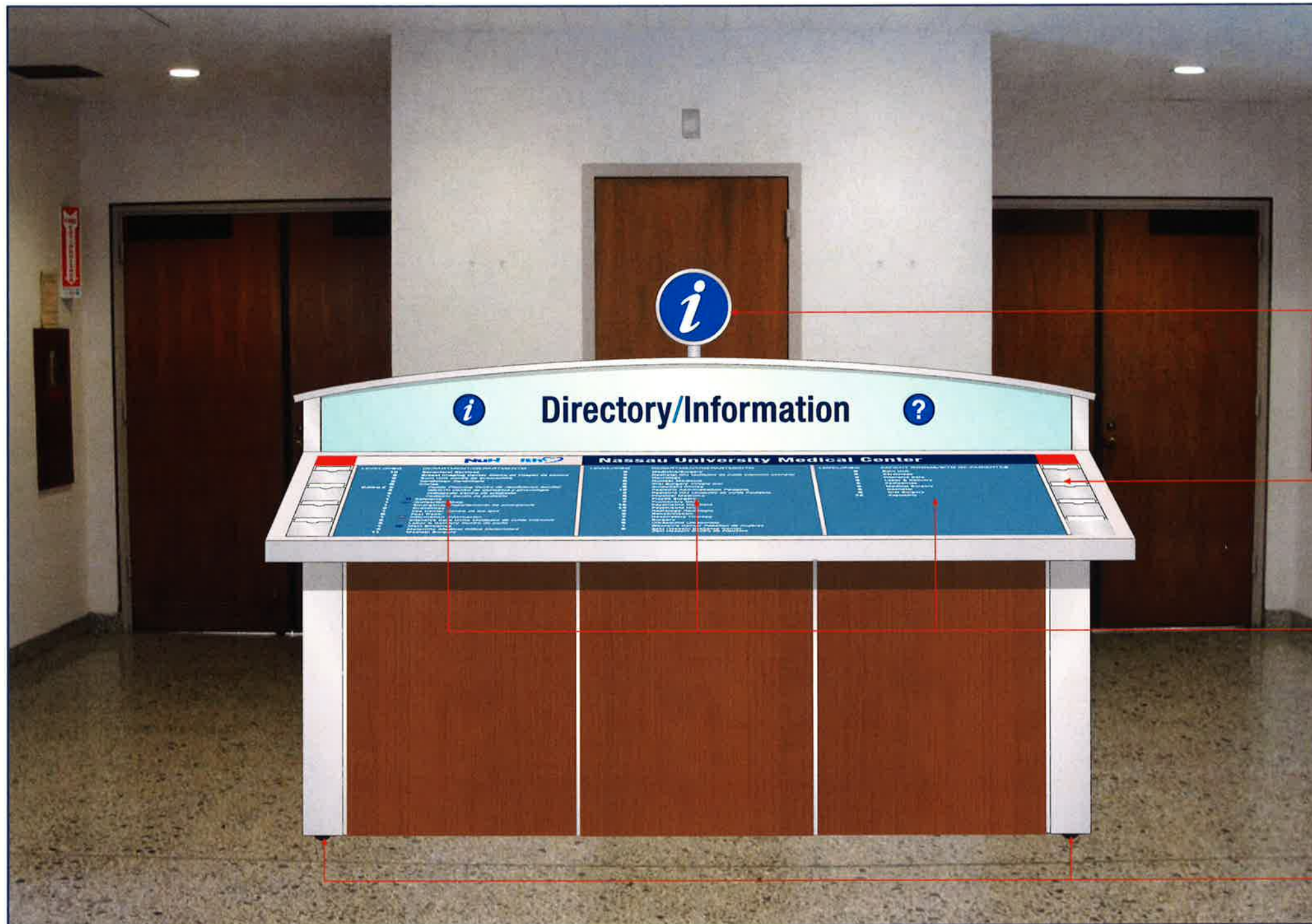

Info symbol
dimensional disk/graphic assembly

Language card holder *typical*
for language translation cards (x 8)

Directory panels
digitally printed graphic insert panels (x 3; changeable)

Rolling casters *typical*
mounted to structural posts

B1 Information Directory *context illustration*
i Scale: relative to image

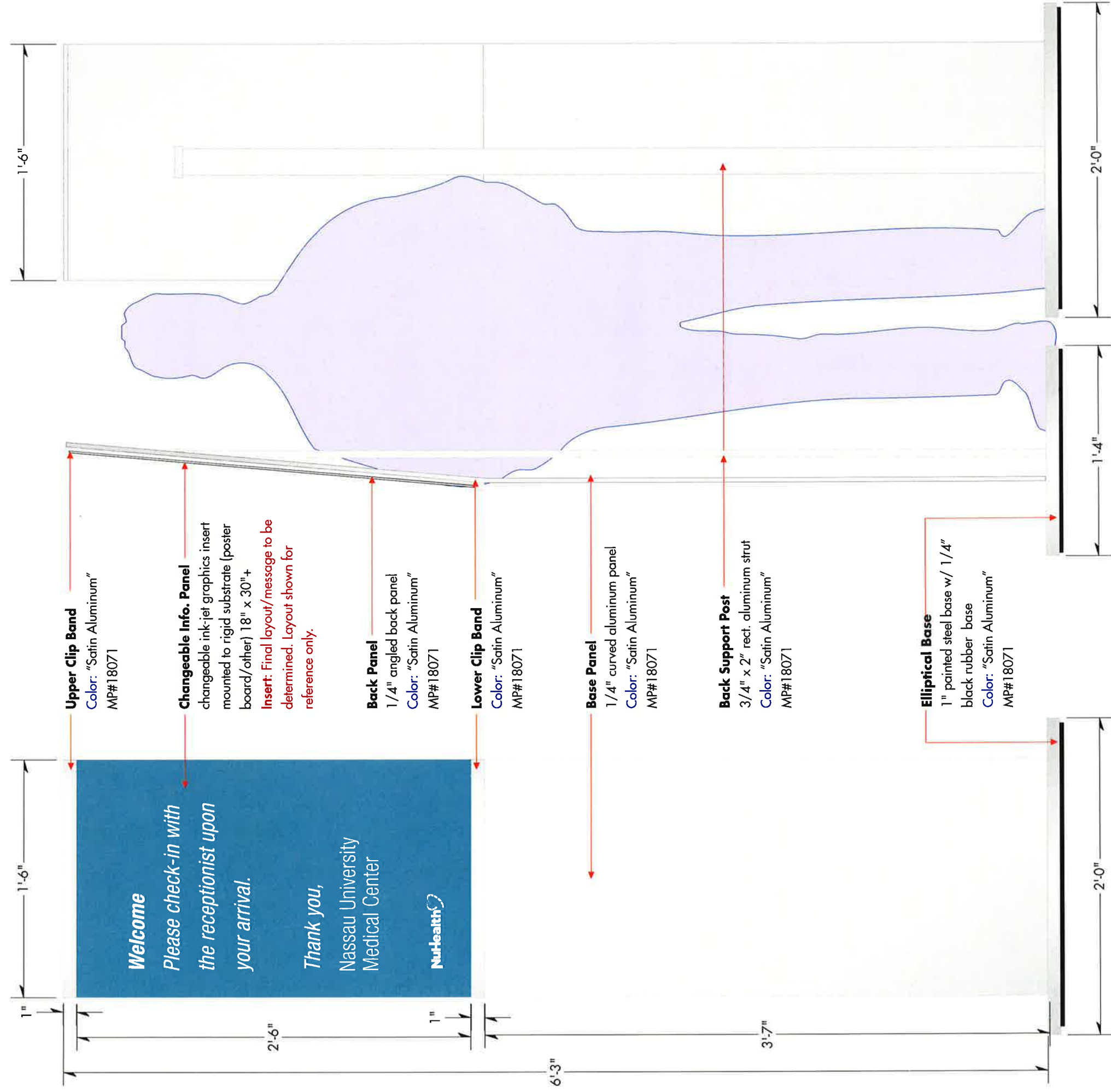

A

Freestanding B2 changeable printed insert freestanding

Scale: 1 1/2" = 1'-0"

Side View

Rear View



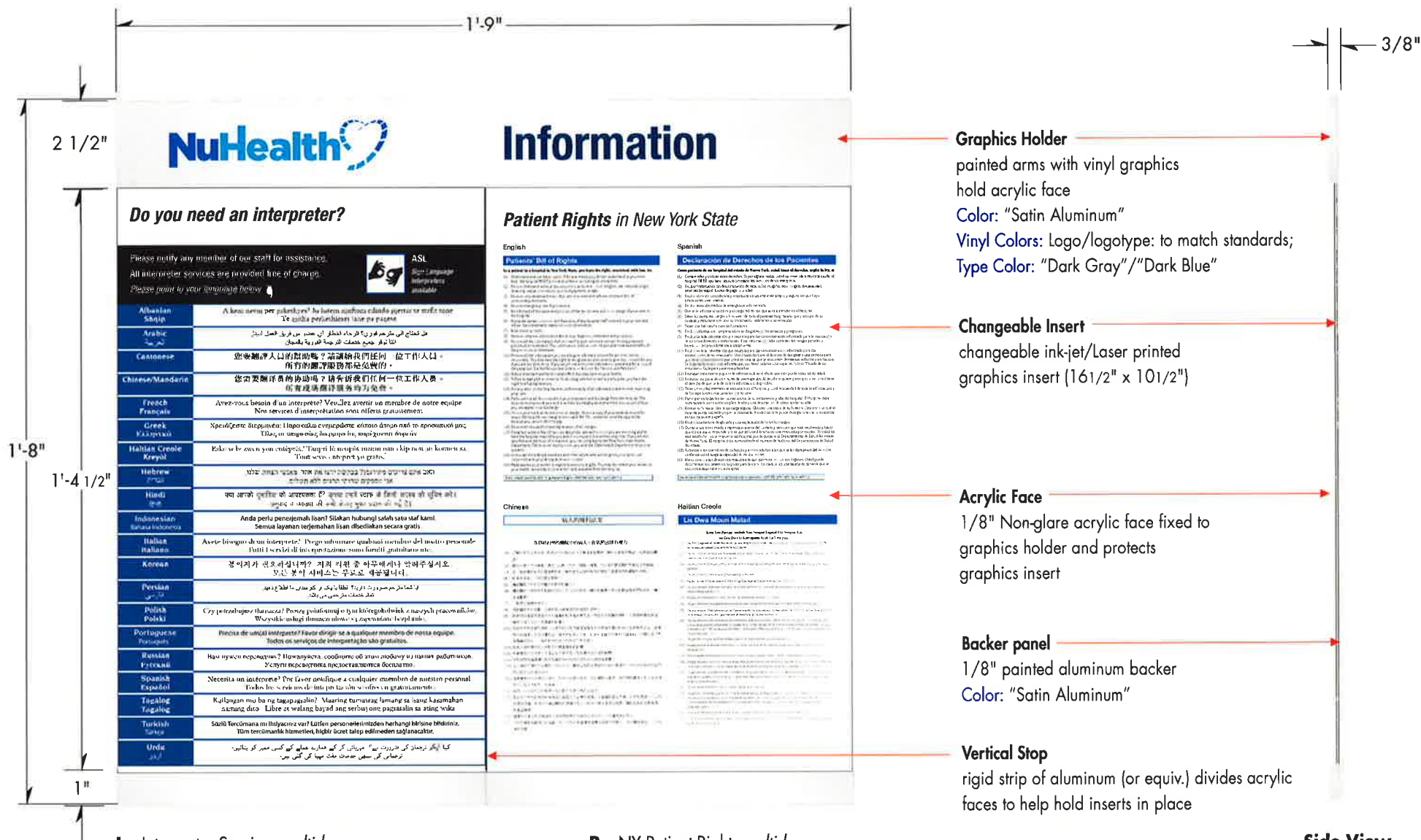

L – Interpreter Services *multi-language*

R – NY Patient Rights *multi-language:*
 • English, Spanish, Haitian Creole, Chinese

B3.1 Changeable Insert Holder 11" x 17"
 Single-sided, interior sign with changeable graphic inserts fabricated per notes shown.
 Qty: ____ (TBD)

B3
1 Changeable Armature double panel wall mounted
 Scale: 3" = 1'-0"



INTERIOR SIGN SYSTEM NASSAU UNIVERSITY MEDICAL CENTER



ENVIRONMENTAL GRAPHICS
Gamble Design LLC
 154 Maplewood Avenue
 Portsmouth NH 03801
 ☎ 603.427.1300

INTERIOR DESIGN
TRO Jung|Brannen
 22 Boston Wharf Road
 Boston MA 02210
 ☎ 617.502.3400

DRAWING TITLE
B3 Changeable Armature
 Changeable insert wall-mounted
 Scale: 3" = 1'-0"
 20 August 2010

DRAWING N°

B3.1

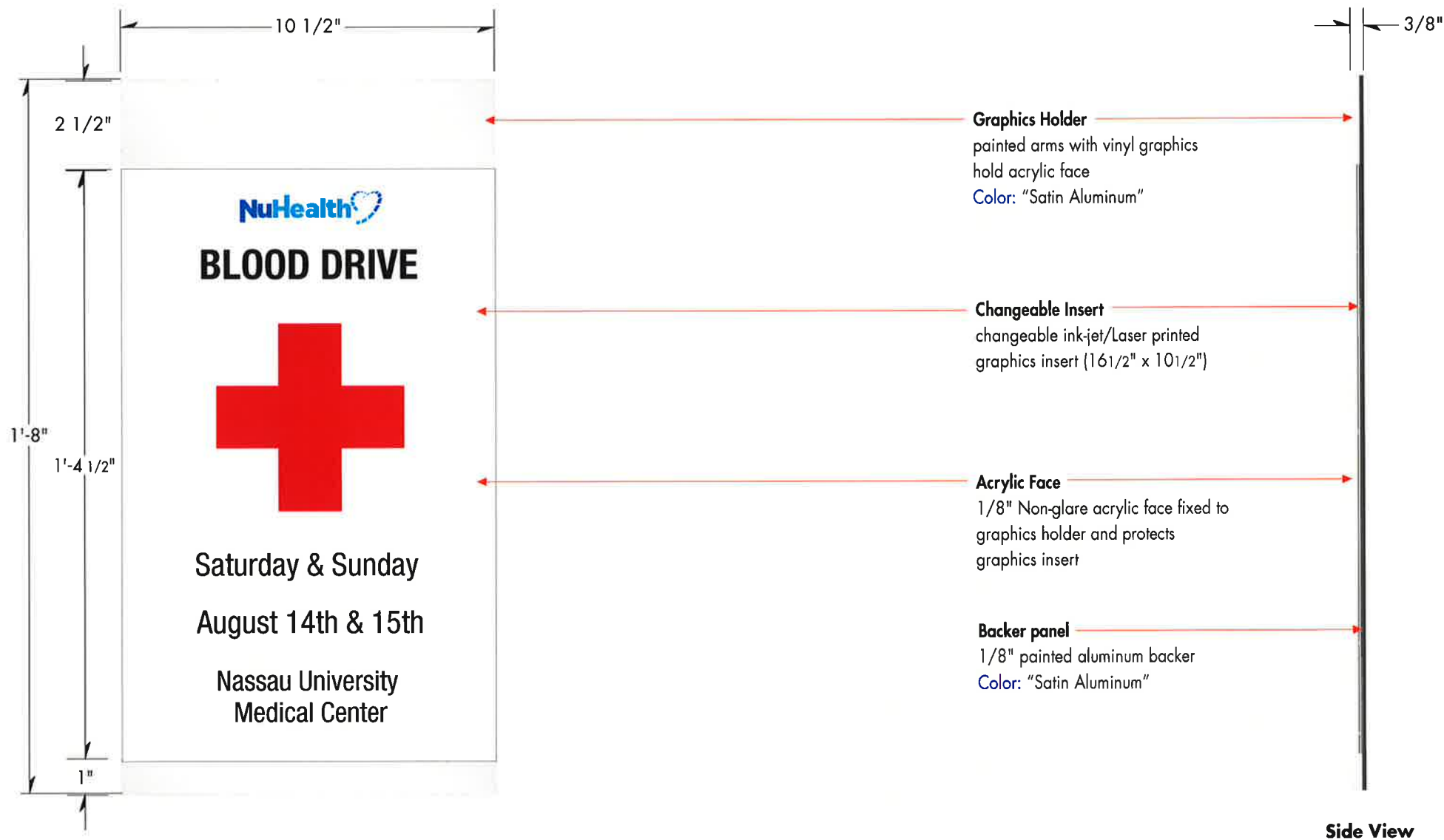

B4.1 Changeable Insert Holder 11" x17"
Single-sided, interior sign with changeable
graphic inserts fabricated per notes shown.
Qty: ____ (TBD)

B4 **1** **Changeable Armature** single panel wall mounted
Scale: 3" = 1'-0"



INTERIOR SIGN SYSTEM NASSAU UNIVERSITY MEDICAL CENTER



ENVIRONMENTAL GRAPHICS
Gamble Design LLC
154 Maplewood Avenue
Portsmouth NH 03801
603.427.1300

INTERIOR DESIGN
TRO Jung|Brannen
22 Boston Wharf Road
Boston MA 02210
617.502.3400

DRAWING TITLE
B4 Changeable Armature
Changeable insert wall-mounted
Scale: 3" = 1'-0"
20 August 2010

DRAWING N°

B4.1

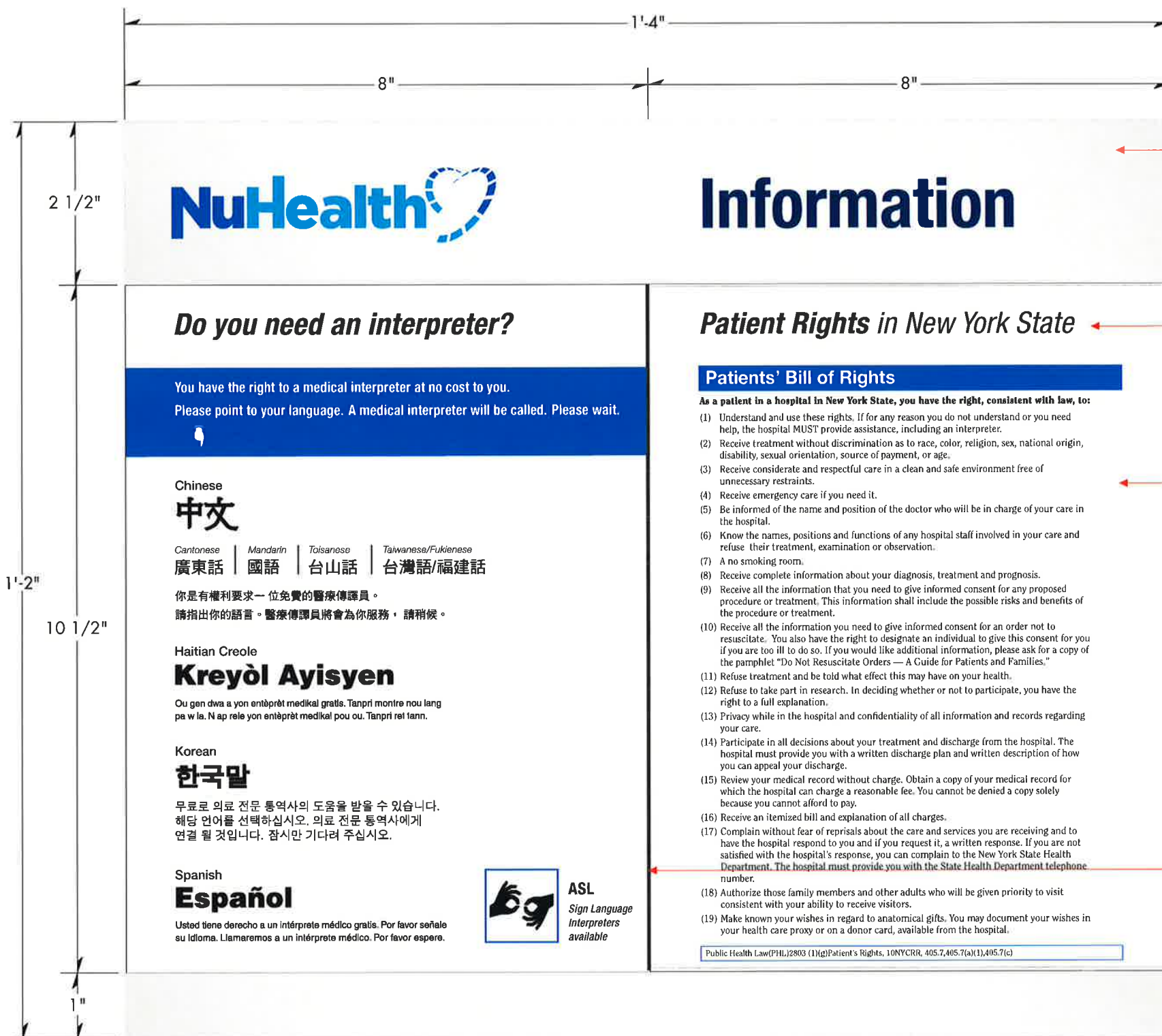

- Graphics Holder**
painted arms with vinyl graphics
hold acrylic face
Color: "Satin Aluminum"
Vinyl Colors: Logo/logotype: to match standards;
Type Color: "Dark Gray"/"Dark Blue"
- Changeable Insert**
changeable ink-jet/Laser printed graphics insert (16 1/2" x 10 1/2")
- Acrylic Face**
1/8" Non-glare acrylic face fixed to graphics holder and protects graphics insert
- Backer panel**
1/8" painted aluminum backer
Color: "Satin Aluminum"
- Vertical Stop**
rigid strip of aluminum (or equiv.) divides acrylic faces to help hold inserts in place

Side View

L – Interpreter Services *four languages*:
• Chinese, Haitian Creole, Korean, Spanish + ASL

R – NY Patient Rights *English*

B5 **Changeable Armature** double insert wall-mounted
1 Scale: 1: 2 half full size

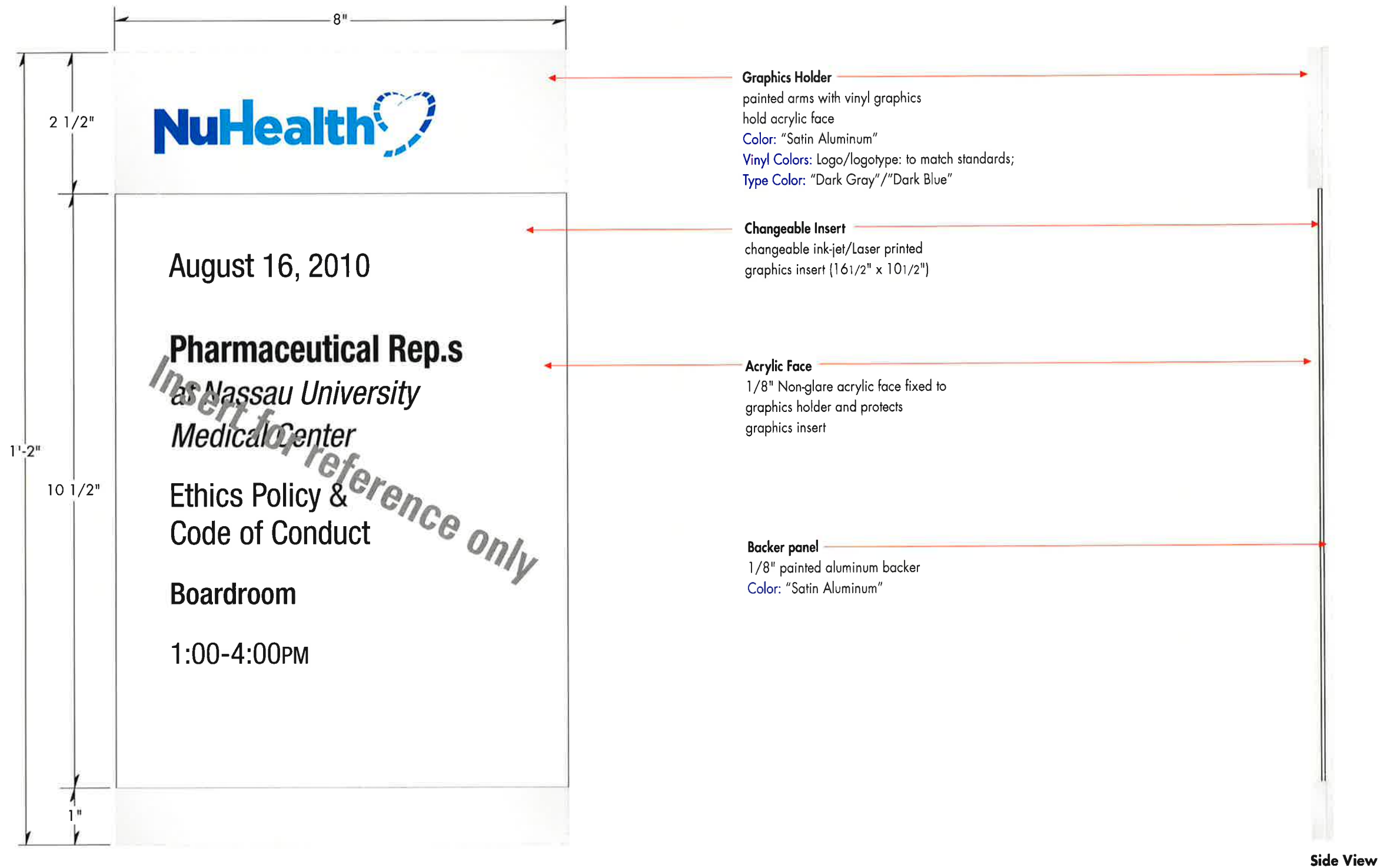

B6 Changeable Armature wall-mounted
1 Scale: 1: 2 half full size



INTERIOR SIGN SYSTEM NASSAU UNIVERSITY MEDICAL CENTER



ENVIRONMENTAL GRAPHICS
Gamble Design LLC
 154 Maplewood Avenue
 Portsmouth NH 03801
 ☎ 603.427.1300

INTERIOR DESIGN
TRO Jung|Brannen
 22 Boston Wharf Road
 Boston MA 02210
 ☎ 617.502.3400

DRAWING TITLE
B6 Changeable Armature
 Changeable 8"x 10.5"
 Scale: half full size
 20 August 2010

DRAWING N°

B6.1

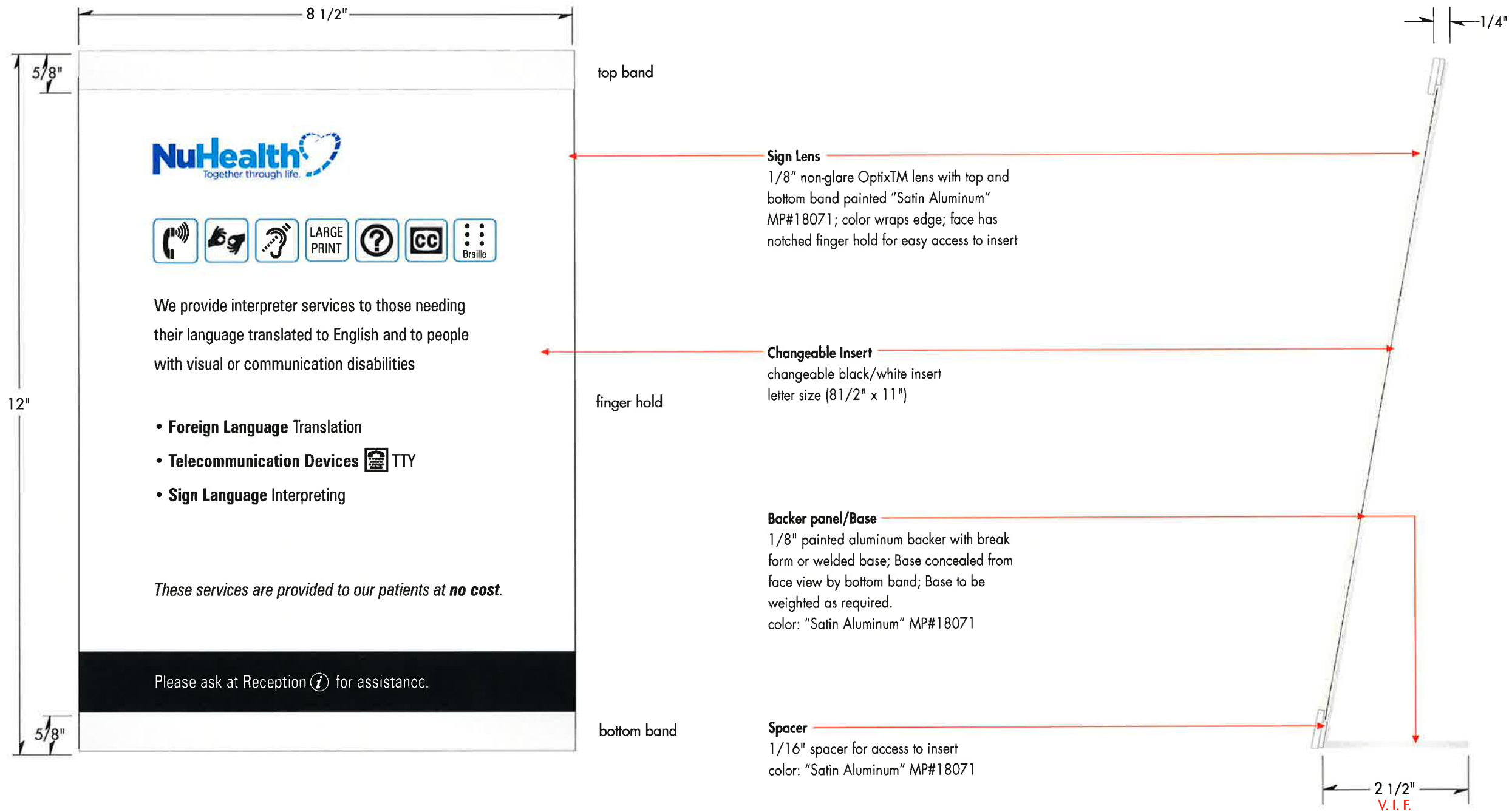

SPECIFICATION NOTES:
 Fabrication: Single-sided, interior sign with changeable graphics insert panel fabricated per notes shown.

B7 Changeable Armature desk-mounted
 1 Scale: 1: 2 half full size

Side View



INTERIOR SIGN SYSTEM NASSAU UNIVERSITY MEDICAL CENTER



ENVIRONMENTAL GRAPHICS
Gamble Design LLC
 154 Maplewood Avenue
 Portsmouth NH 03801
 ☎ 603.427.1300

INTERIOR DESIGN
TRO Jung|Brannen
 22 Boston Wharf Road
 Boston MA 02210
 ☎ 617.502.3400

DRAWING TITLE
B7 Changeable Armature
 Changeable desk 8"x 10.5"
 Scale: half full size
 20 August 2010

DRAWING N°

B7.1

SPECIFICATION NOTES:

Fabrication: Single-sided, interior sign with changeable graphics insert panel fabricated per notes shown.



B8.1 Multi-Changeable Information Holder 8.5" x 11" (x4)

Graphics Holder
painted aluminum bands hold polycarbonate face; paint color: "Satin Aluminum" MP#18071

Changeable Insert
changeable ink-jet/Laser graphics insert (8.5" x 11")

Lens
1/8" +/- "non-glare" polycarbonate panel held by horizontal bands protects graphics insert

Backer panel
1/8" painted aluminum backer color: "Satin Aluminum" MP#18071

A Changeable Information wall/glass mounted
Scale: 3" = 1'-0"

Side View



ENVIRONMENTAL GRAPHICS
Gamble Design LLC
1.54 Maplewood Avenue
Portsmouth NH 03801
☎ 603.427.1300

INTERIOR DESIGN
TRO Jung | Brannen
22 Boston Wharf Road
Boston MA 02210
☎ 617.502.3400

DRAWING TITLE
Changeable Information

Wall mounted
Scale: as shown
20 August 2010

DRAWING N°

B8.1

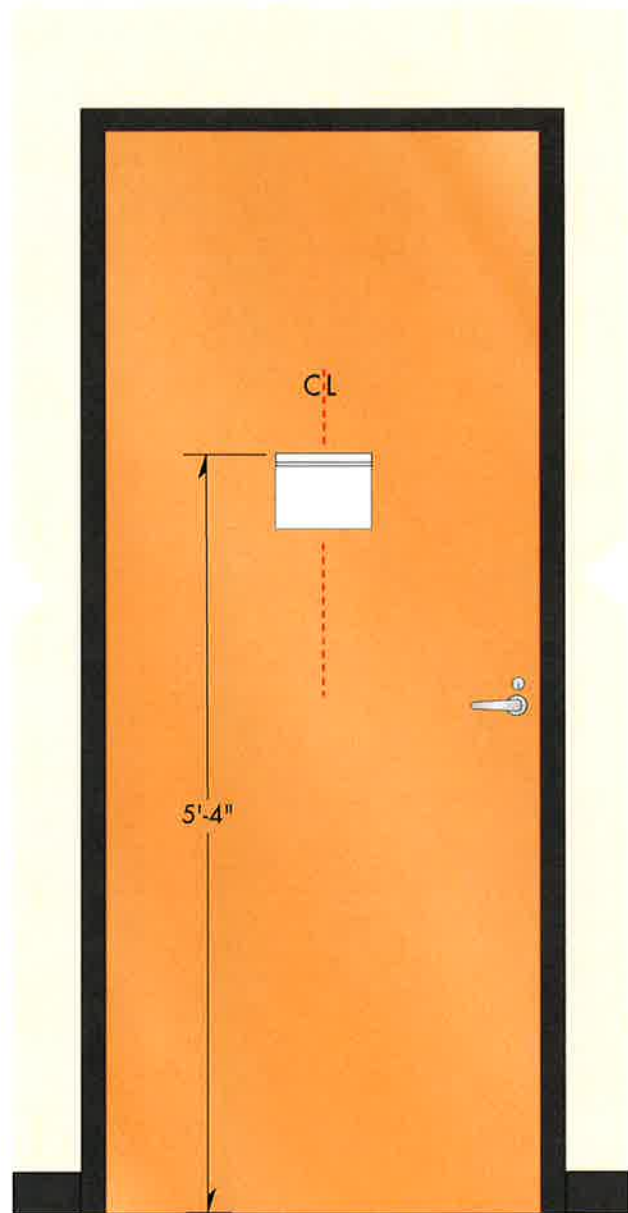

Notifier Bar
 "Satin Aluminum" notifier bar
 MP#18071; IF mounted directly to
 glass USE "Silver Metallic"
 3M#220-217 vinyl backer

Standard Sizes
 Notifier bar comes in 6", 8", 10",
 12"
 widths. Satin Aluminum band
 mounts to door

Paper
 8.5x11 temporary paper insert

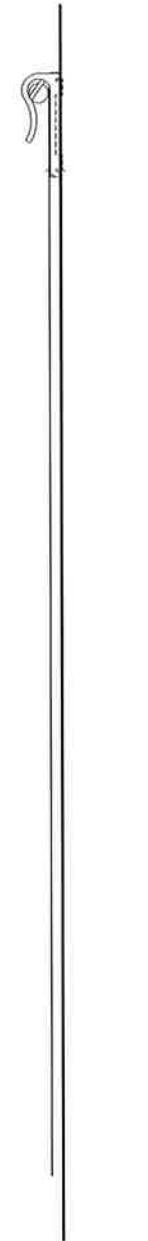

Side View

A Notifier Clip/Bar door mounted
 Scale: 3/4" = 1'-0"

B Notifier Clip/Bar detail
 Scale: 1:2 half full size



INTERIOR SIGN SYSTEM NASSAU UNIVERSITY MEDICAL CENTER



ENVIRONMENTAL GRAPHICS
Gamble Design LLC
 154 Maplewood Avenue
 Portsmouth NH 03801
 ☎ 603.427.1300

INTERIOR DESIGN
TRO Jung | Brannen
 22 Boston Wharf Road
 Boston MA 02210
 ☎ 617.502.3400

DRAWING TITLE
Notifier Clip/Bar
 Door/wall mounted
 Scale: as shown
 20 August 2010

DRAWING N°

B9.1



Existing condition

NuHealth staff to REMOVE all existing signs & repaint damaged wall/door surfaces

Specifications:

Vinyl graphics applied to painted 1/16" aluminum panel. Sign panel mounted to door with hidden mechanical fasteners, silicon and/or 3M®VHB foamtape per interior arch. conditions.

Paint colors:

Sign Panel: "Satin Aluminum" MP#18071

Vinyl colors:

"White" 3M#220-10

"Tomato Red" 3M#220-13

"Dark Blue Metallic" 3M#220-217

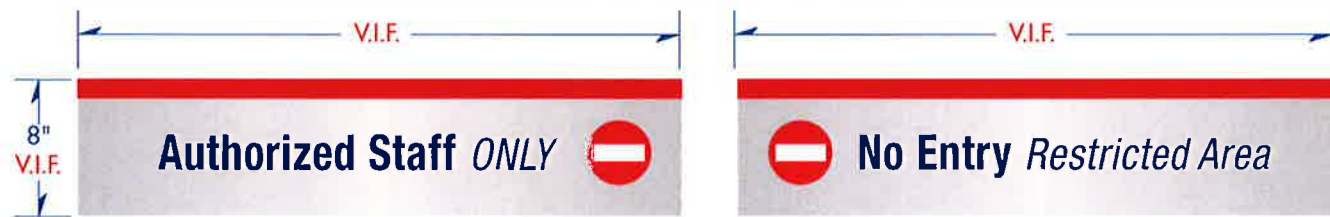

A Primary Restriction double doors
Scale: 1" = 1'-0"



INTERIOR SIGN SYSTEM NASSAU UNIVERSITY MEDICAL CENTER



ENVIRONMENTAL GRAPHICS
Gamble Design LLC
154 Maplewood Avenue
Portsmouth NH 03801
603.427.1300

INTERIOR DESIGN
TRO Jung|Brannen
22 Boston Wharf Road
Boston MA 02210
617.502.3400

DRAWING TITLE
Primary Restriction
Door mounted panel
Scale: as shown
20 August 2010

DRAWING N°

C1.1

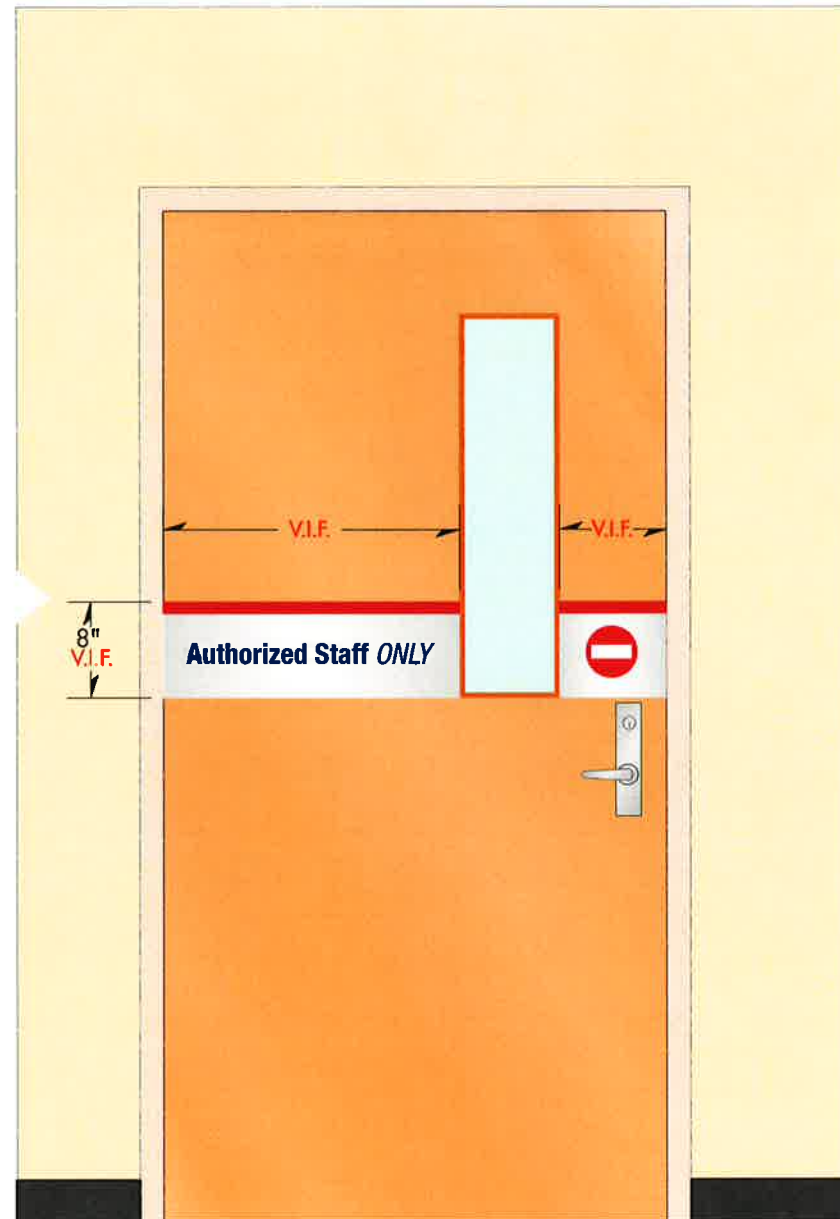

Specifications:

Vinyl graphics applied to painted 1/16" aluminum panel. Sign panel mounted to door with hidden mechanical fasteners, silicon and/or 3M@VHB foamtape per interior arch. conditions.

Paint colors:

Sign Panel: "Satin Aluminum" MP#18071

Vinyl colors:

"White" 3M#220-10

"Tomato Red" 3M#220-13

"Black" 3M#220-12

"Dark Blue Metallic" 3M#220-217

A **Secondary Restriction** single door/at Staff Entry
Scale: 3/4" = 1'-0"



INTERIOR SIGN SYSTEM NASSAU UNIVERSITY MEDICAL CENTER



ENVIRONMENTAL GRAPHICS
Gamble Design LLC
154 Maplewood Avenue
Portsmouth NH 03801
☎ 603.427.1300

INTERIOR DESIGN
TRO Jung|Brannen
22 Boston Wharf Road
Boston MA 02210
☎ 617.502.3400

DRAWING TITLE
Secondary Restriction
Enter/do not enter graphics *door mounted*
Scale: *half full size*
20 August 2010

DRAWING N°

C2.1

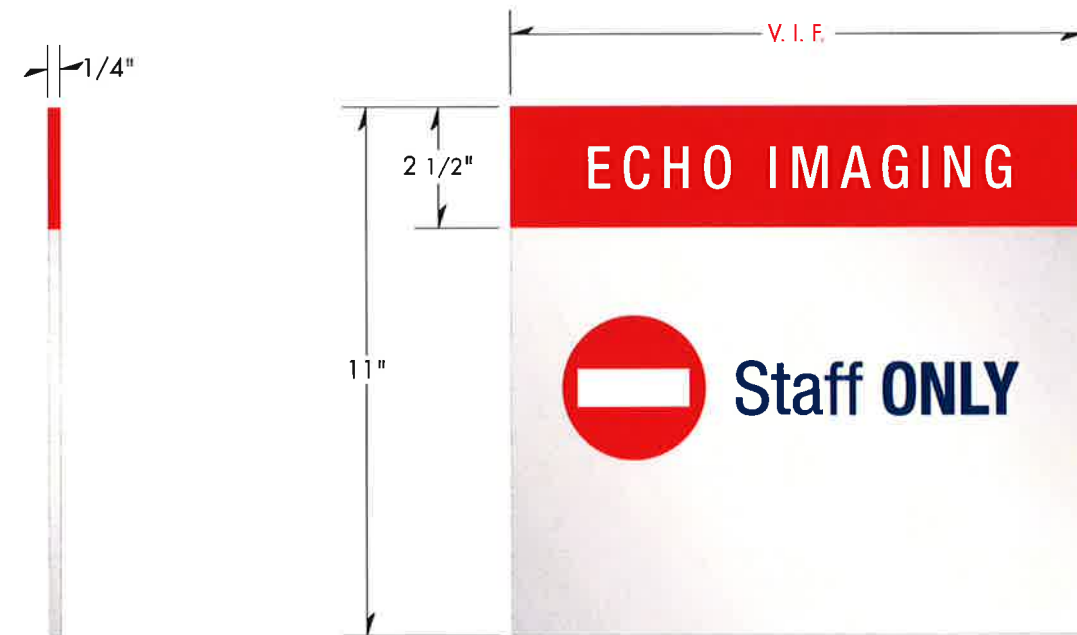

Sign Panel Regulatory
 1/4" panel with vinyl graphics flush mounted to wall; Paint panel "Satin Aluminum" MP#18071 with vinyl graphics

Vinyl colors:
 "Black" 3M#220-12
 "White" 3M#220-10
 "Tomato Red" 3M#220-13
 "Dark Blue Metallic" 3M#220-217

Mounting
 Mount in location shown; field verify measurements

C3 Secondary Restriction flat panel wall mounted
 1 Scale: relative to image

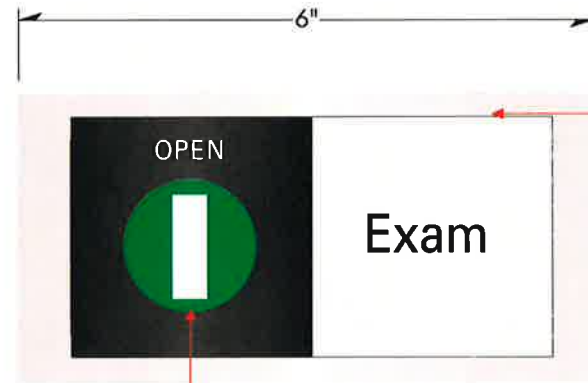
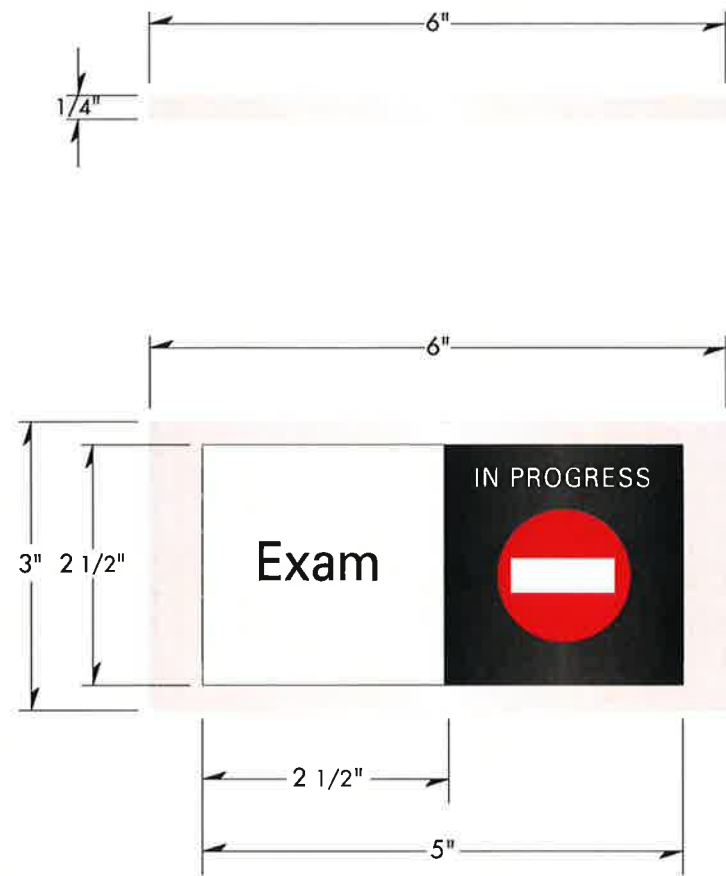

Sign Panel

1/4" painted sign panel with vinyl graphics and slider bar; paint "Satin Aluminum" Akzo Nobel #359 D-3 with "Black" Akzo Nobel #509 H-3 background and vinyl graphics; mount centered on door where required

Vinyl Graphics

Colors:
 "White" 3M#220-10
 "Black" 3M#220-12
 "Bright Green" 3M#220-186
 "Tomato Red" 3M#220-13



Existing



A Room Slider enter/do not enter graphics door mounted
 Scale: 1:2 half full size

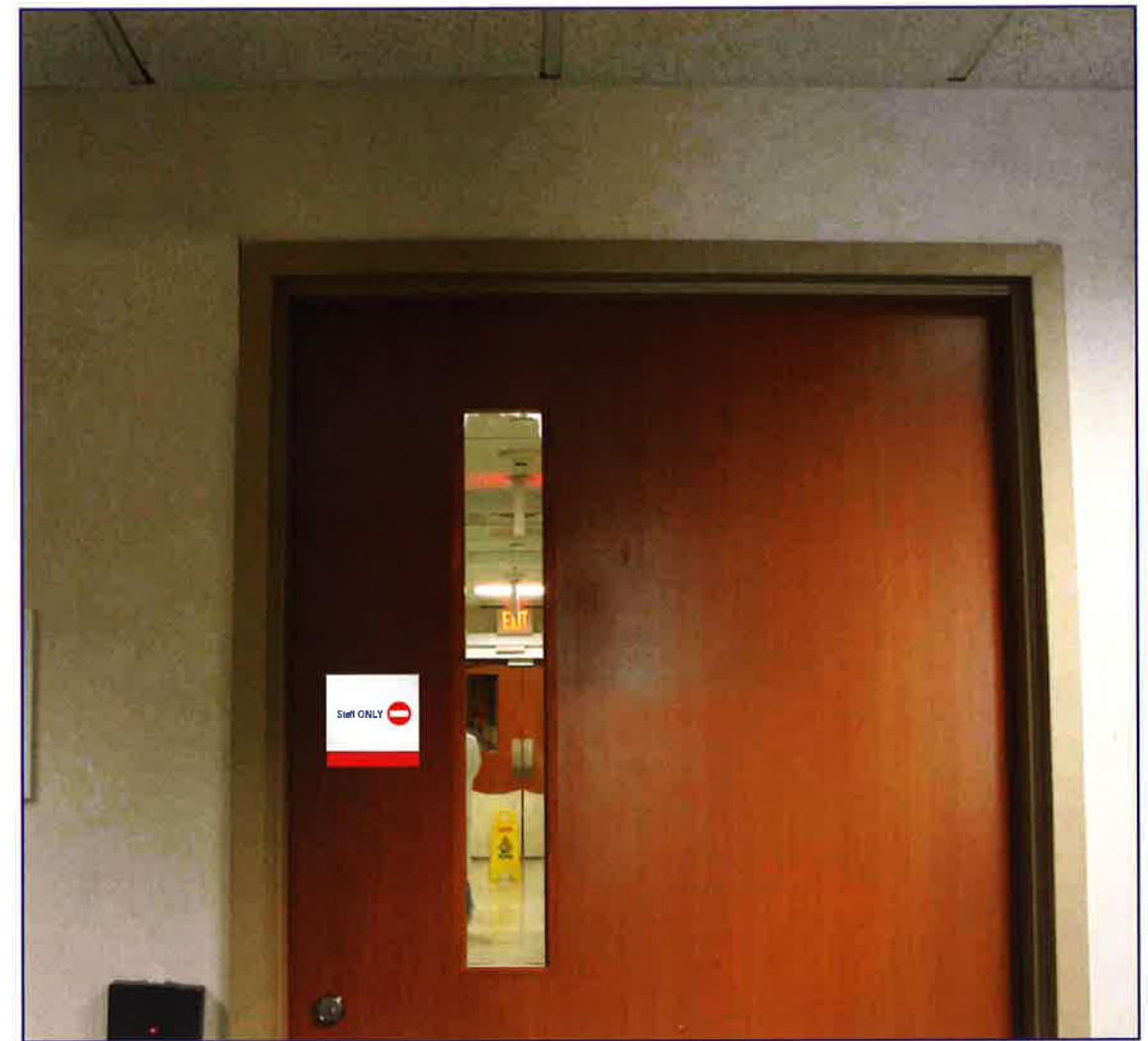
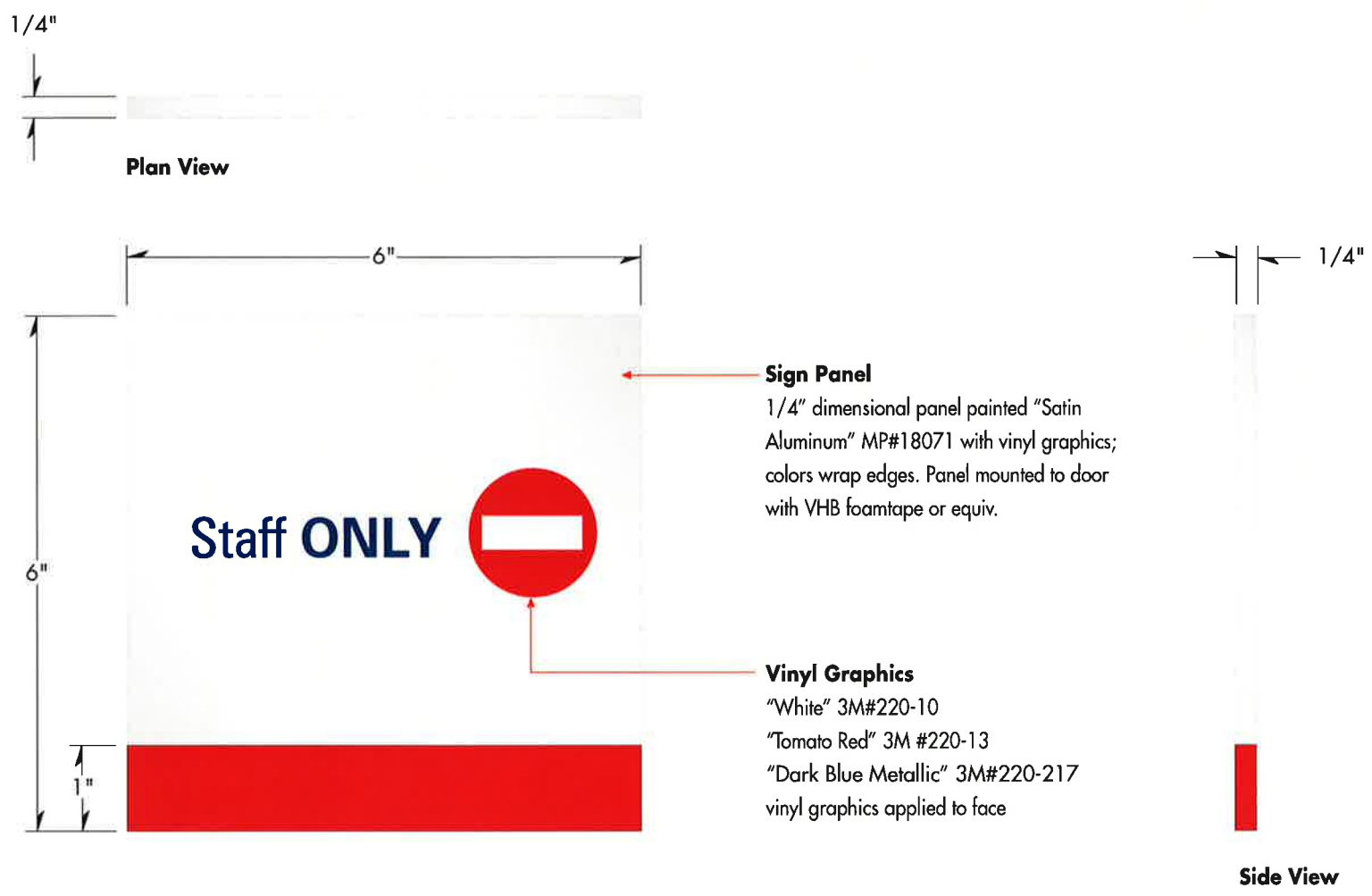

C5 **Staff ONLY** restricted door/wall mounted
1 Scale: 1:2 half full size



INTERIOR SIGN SYSTEM NASSAU UNIVERSITY MEDICAL CENTER



ENVIRONMENTAL GRAPHICS
Gamble Design LLC
154 Maplewood Avenue
Portsmouth NH 03801
603.427.1300

INTERIOR DESIGN
TRO Jung|Brannen
22 Boston Wharf Road
Boston MA 02210
617.502.3400

DRAWING TITLE
Staff ONLY
Restricted dor/wall mounted
Scale: as shown
20 August 2010

DRAWING N°
C5.1



Layout B

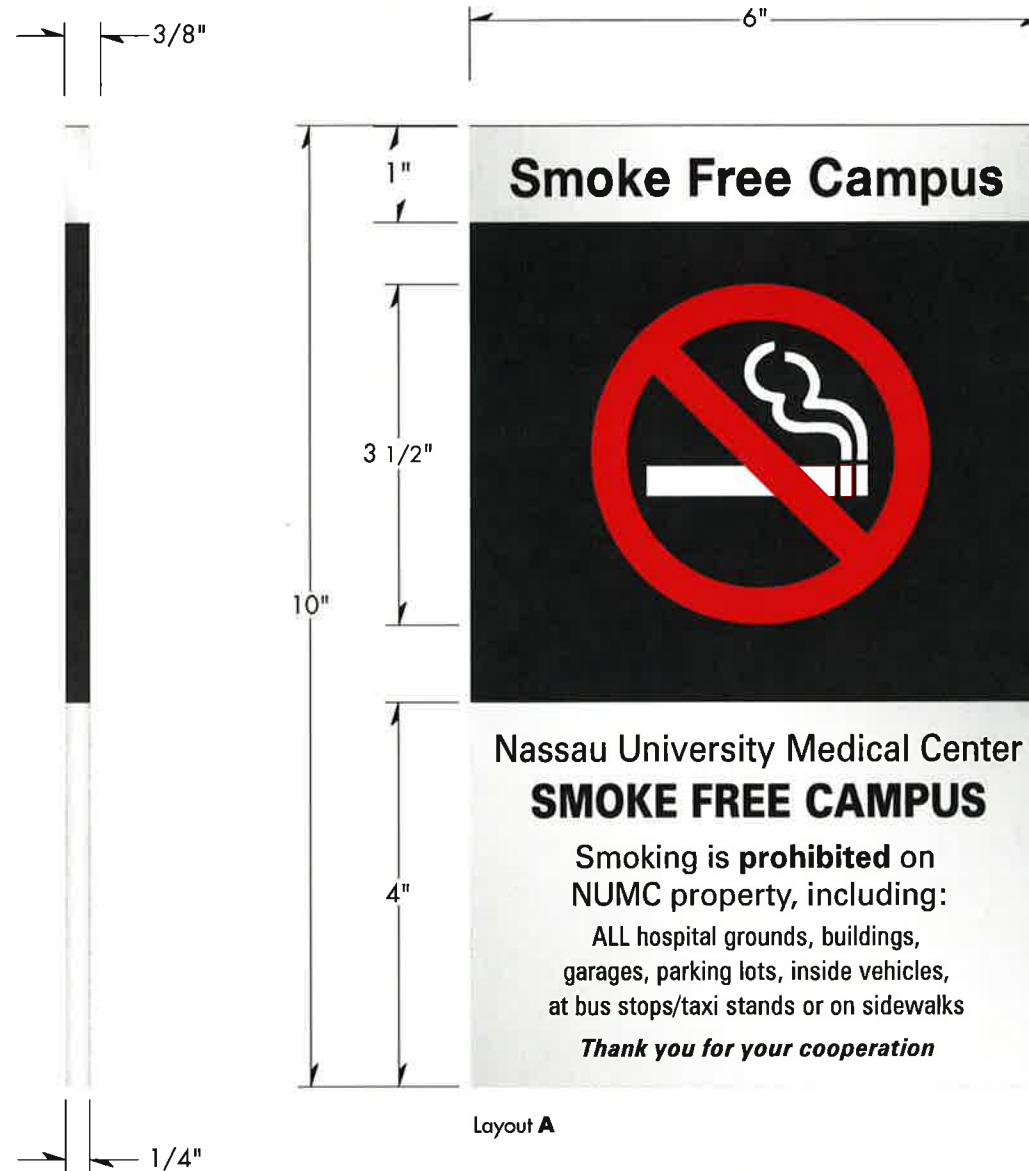

Layout A

C7 Specs:

Sign graphics silk-screened to painted 1/4" acrylic substrate. Sign graphics and paint colors to match system standards. Sign assembly mounted to wall/column/post with hidden mechanical fasteners, silicon and/or 3M@VHB foamtape per exterior/interior conditions.

Qty: exact quantity tbd with Owner

Paint colors:

- Top band: "Satin Aluminum" MP#18071
- "Black" MP#25595
- "Bright Yellow" MP#14004

Vinyl colors:

- "Black" 3M#220-12
- "White" 3M#220-10
- "Tomato Red" 3M#220-13

C7 Tobacco Free final layout/content TBD
1 Scale: 1:2 one half actual size



INTERIOR SIGN SYSTEM NASSAU UNIVERSITY MEDICAL CENTER



ENVIRONMENTAL GRAPHICS
Gamble Design LLC
154 Maplewood Avenue
Portsmouth NH 03801
603.427.1300

INTERIOR DESIGN
TRO Jung|Brannen
22 Boston Wharf Road
Boston MA 02210
617.502.3400

DRAWING TITLE
Tobacco Free ID
Wall mounted
Scale: as shown
20 August 2010

DRAWING N°

C7.1



C8.A Fragrance Free



C8.B Fragrance Free

Header Band typical
 "Black" or "Yellow" Band with vinyl message;
 Vinyl colors: "Black" 3M#220-12, "White" 3M#220-10, "Bright Yellow" 3M#220-15

Sign Panel typical
 1/8" painted panel "Satin Aluminum" MP#18071 with vinyl graphics in colors shown;
 Graphics colors: "Black" 3M#220-12, "Tomato Red" 3M#220-13

Mounting
 Wall mounted or desk mounted

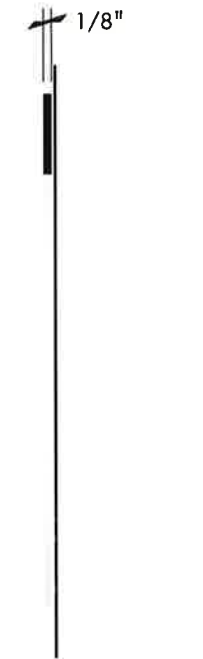

Wall Mounted

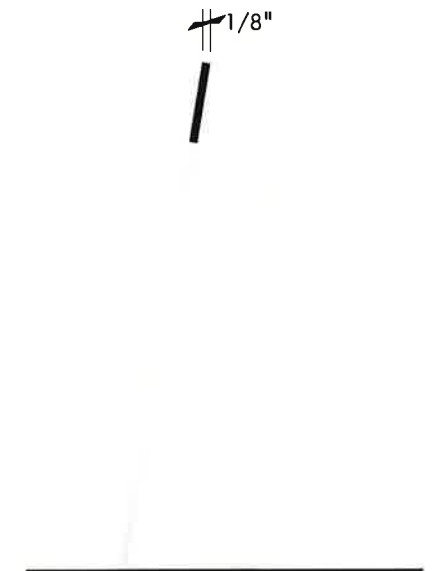

Desk Mounted



DG.A

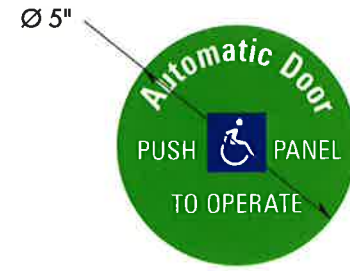

DG.B



DG.C



DG.D

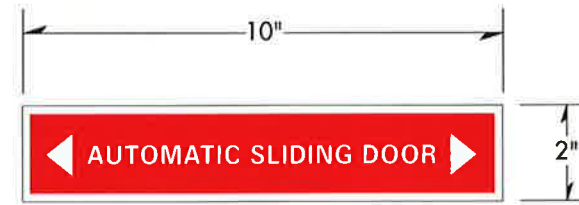

DG.E



DG.F

Quantities:

For each C9.1 location price

DG.A Qty: 2 (two)

DG.B Qty: 2 (two)

DG.C Qty: 2 (two)

DG.D Qty: 2 (two)

DG.E Qty: 2 (two)

DG.F Qty: 2 (two)



Door Graphics vinyl graphics *automatic/sliding doors*

Scale: 3" = 1'-0"



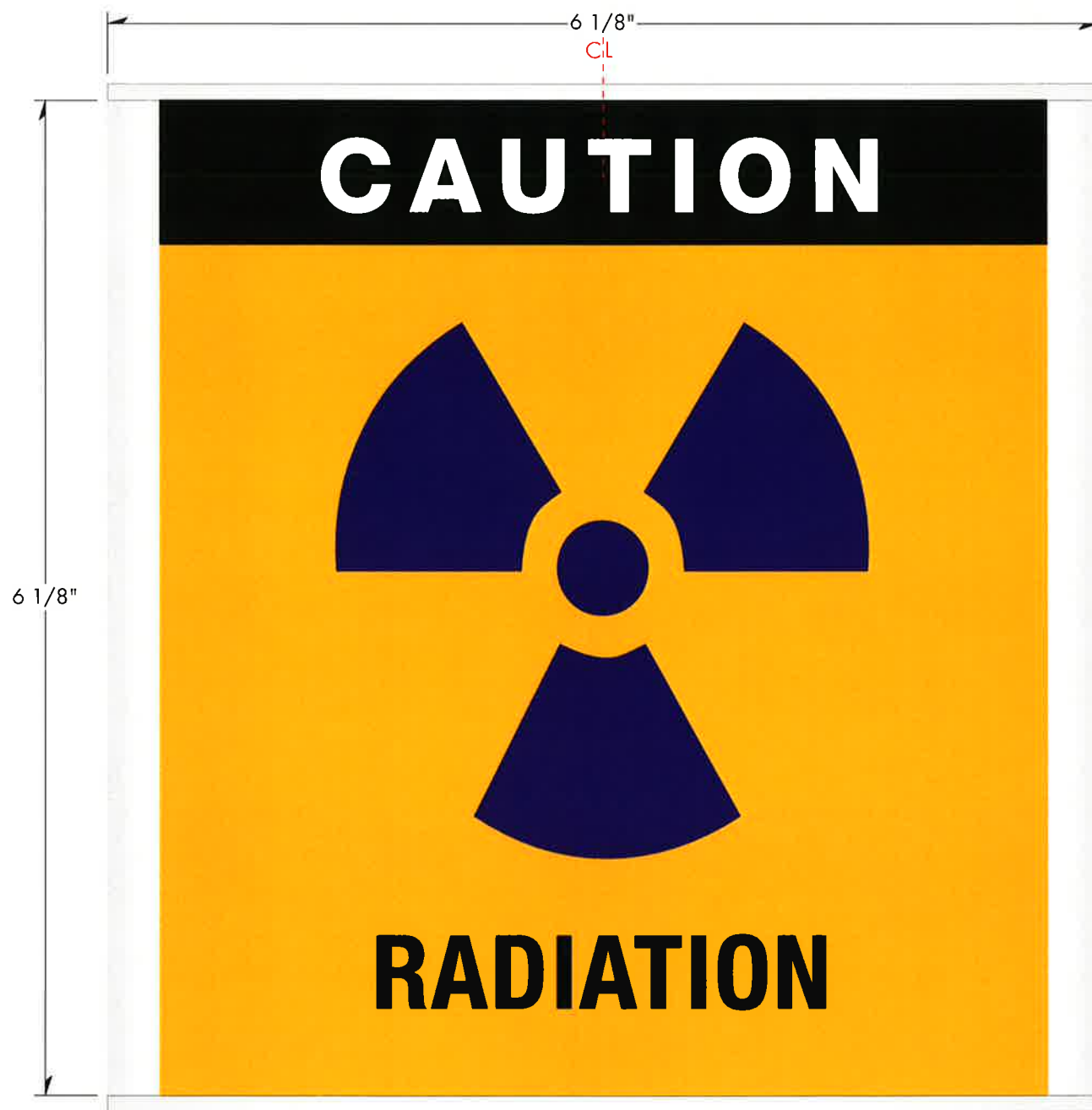

Layout A



Layout B

C10 Specifications

Standard ClearPath armature in size shown. Printed insert with clear non glare lens. Sign mounts centered on door.

ClearPath Armature

Frame Triline/Hi-Tech with Ellipse edge treatment/silver
Profile code TLHT248E-S
 Contact: Emily Cordes @ ClearPath
 ☎ 419.429.3864

Armature/Fabricator NOTES:

- Armature: Silver Anodize
- Lens: Clear non-glare lens
- NEW cap: To replace top cap of sign extrusion *by fabricator*. Provide prototype to Designer for approval.
- Tactile Braille insert *by fabricator*

C10 Radiation insert graphics door mounted
 1 Scale: 1:1 actual size



INTERIOR SIGN SYSTEM NASSAU UNIVERSITY MEDICAL CENTER



ENVIRONMENTAL GRAPHICS
Gamble Design LLC
 154 Maplewood Avenue
 Portsmouth NH 03801
 ☎ 603.427.1300

INTERIOR DESIGN
TRO Jung|Brannen
 22 Boston Wharf Road
 Boston MA 02210
 ☎ 617.502.3400

DRAWING TITLE
Radiation
 Door mounted
 Scale: as shown
 20 August 2010

DRAWING N°

C10.1

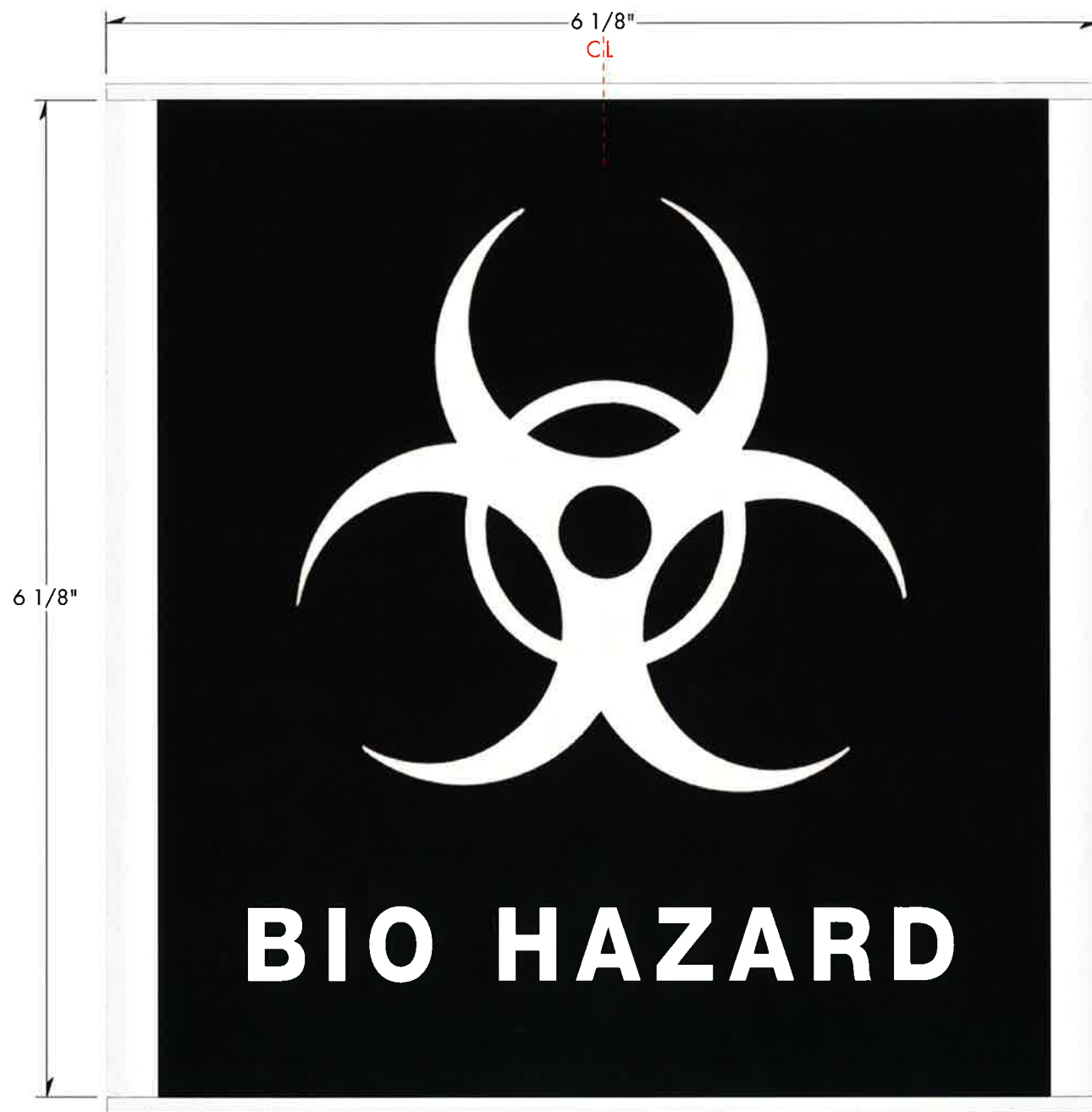

C11 Specifications

Standard ClearPath armature in size shown. Printed insert with clear non glare lens. Sign mounts centered on door.

ClearPath Armature

Frame Triline/Hi-Tech with Ellipse edge treatment/silver
Profile code TLHT248E-S
 Contact: Emily Cordes @ ClearPath
 ☎ 419.429.3864

Armature/Fabricator NOTES:

- Armature: Silver Anodize
- Lens: Clear non-glare lens
- NEW cap: To replace top cap of sign extrusion *by fabricator*. Provide prototype to Designer for approval.
- Tactile Braille insert *by fabricator*

C11 Bio Hazard insert graphics door mounted
 1 Scale: 1:1 actual size

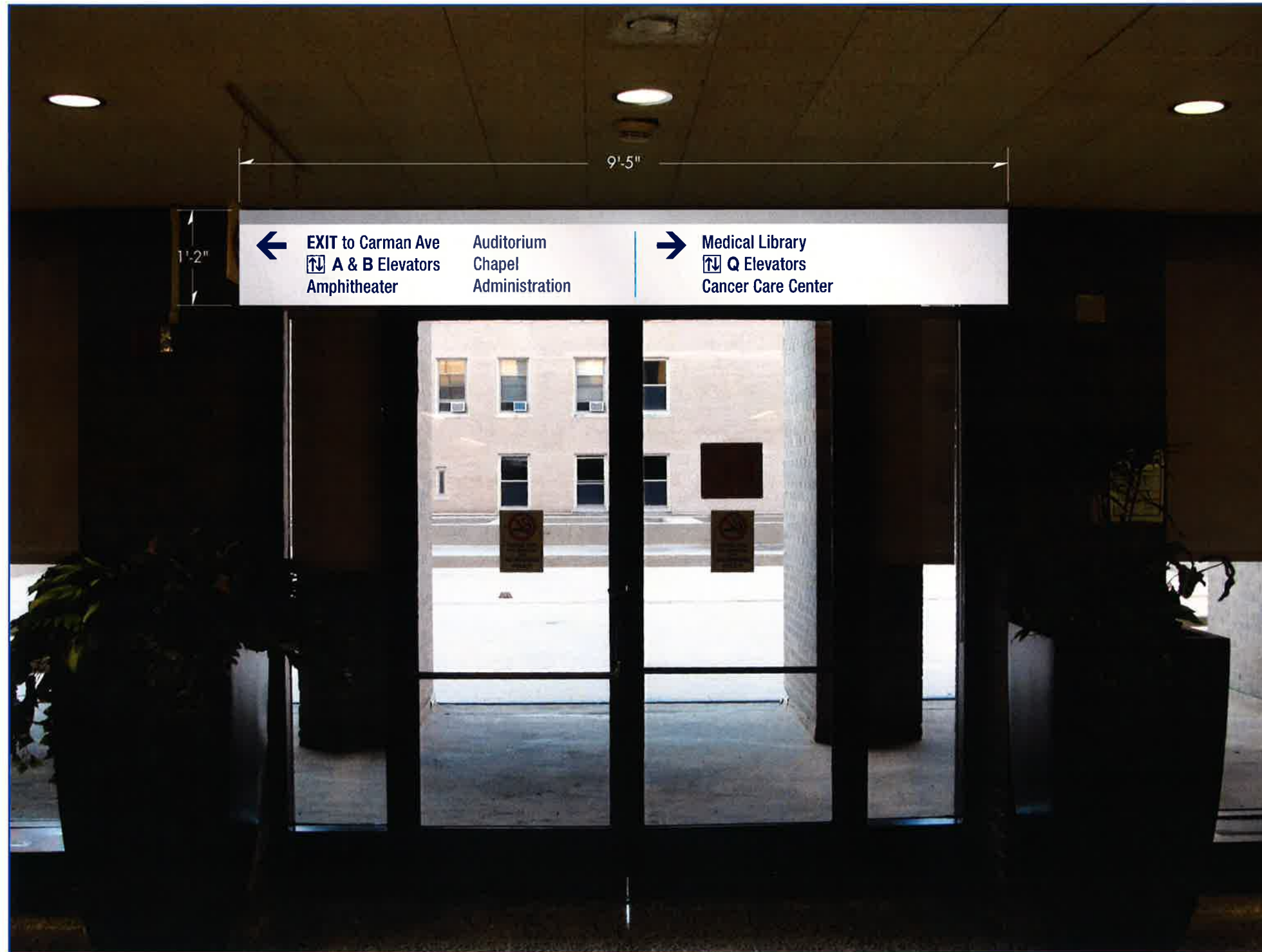

Existing

Overhead projecting/Ceiling-suspended sign (double-sided) consists of painted 3/4" "Extra" substrate or equal with concealed mounting hardware to ACT/other ceiling above OR suspended across corridor from bracket arms so to not penetrate ceiling. Band/finish all edges. Paint "Satin Aluminum" with accent band @ top of sign panel to match sign "Medium Gray Metallic" finish; all graphics are vinyl in colors, fonts and sizes indicated.

Paint colors:

- A) "Medium Gray Metallic" MP#46638
- B) "Satin Aluminum" MP#18071

Vinyl colors:

- "Slate Gray Metallic" 3M#220-201
- "Black" 3M#220-12
- "Dark Blue Metallic" 3M#220-217
- "Olympic Blue" 3M#220-57
- "Matte Blue" 3M#220-407
- "Delft Blue" 3M#230-97

D1 Primary Directional overhead directional
1 Scale: 1" = 1'-0"



INTERIOR SIGN SYSTEM NASSAU UNIVERSITY MEDICAL CENTER



ENVIRONMENTAL GRAPHICS
Gamble Design LLC
154 Maplewood Avenue
Portsmouth NH 03801
603.427.1300

INTERIOR DESIGN
TRO Jung | Brannen
22 Boston Wharf Road
Boston MA 02210
617.502.3400

DRAWING TITLE
Primary Directional overhead
Column mounted
Scale: as shown
20 August 2010

DRAWING N°

D1.1



Existing

Overhead Directional Sign:

Fascia-mounted: Single sided fascia-mounted sign panel (1/8"-1/4") mounted flush to soffit/fascia with 3M® VHB foamtape and mechanical fasteners in precise alignment with architectural conditions
 "Satin Aluminum" panel with accent band @ top of sign panel paint "Medium Gray Metallic"; all graphics are vinyl in colors, fonts and sizes indicated. Field verify all conditions.

Paint colors:

- A) "Medium Gray Metallic" MP#46638
- B) "Satin Aluminum" MP#18071

Vinyl colors:

- "Slate Gray Metallic" 3M#220-201
- "Black" 3M#220-12
- "Dark Blue Metallic" 3M#220-217
- "Olympic Blue" 3M#220-57
- "Matte Blue" 3M#220-407
- "Delft Blue" 3M#230-97

D1 Primary Directional overhead directional
2 Scale: 1" = 1'- 0"



INTERIOR SIGN SYSTEM NASSAU UNIVERSITY MEDICAL CENTER



ENVIRONMENTAL GRAPHICS
Gamble Design LLC
 154 Maplewood Avenue
 Portsmouth NH 03801
 ☎ 603.427.1300

INTERIOR DESIGN
TRO Jung | Brannen
 22 Boston Wharf Road
 Boston MA 02210
 ☎ 617.502.3400

DRAWING TITLE
Primary Directional overhead
 Fascia mounted
 Scale: as shown
 20 August 2010

DRAWING N°

D1.2

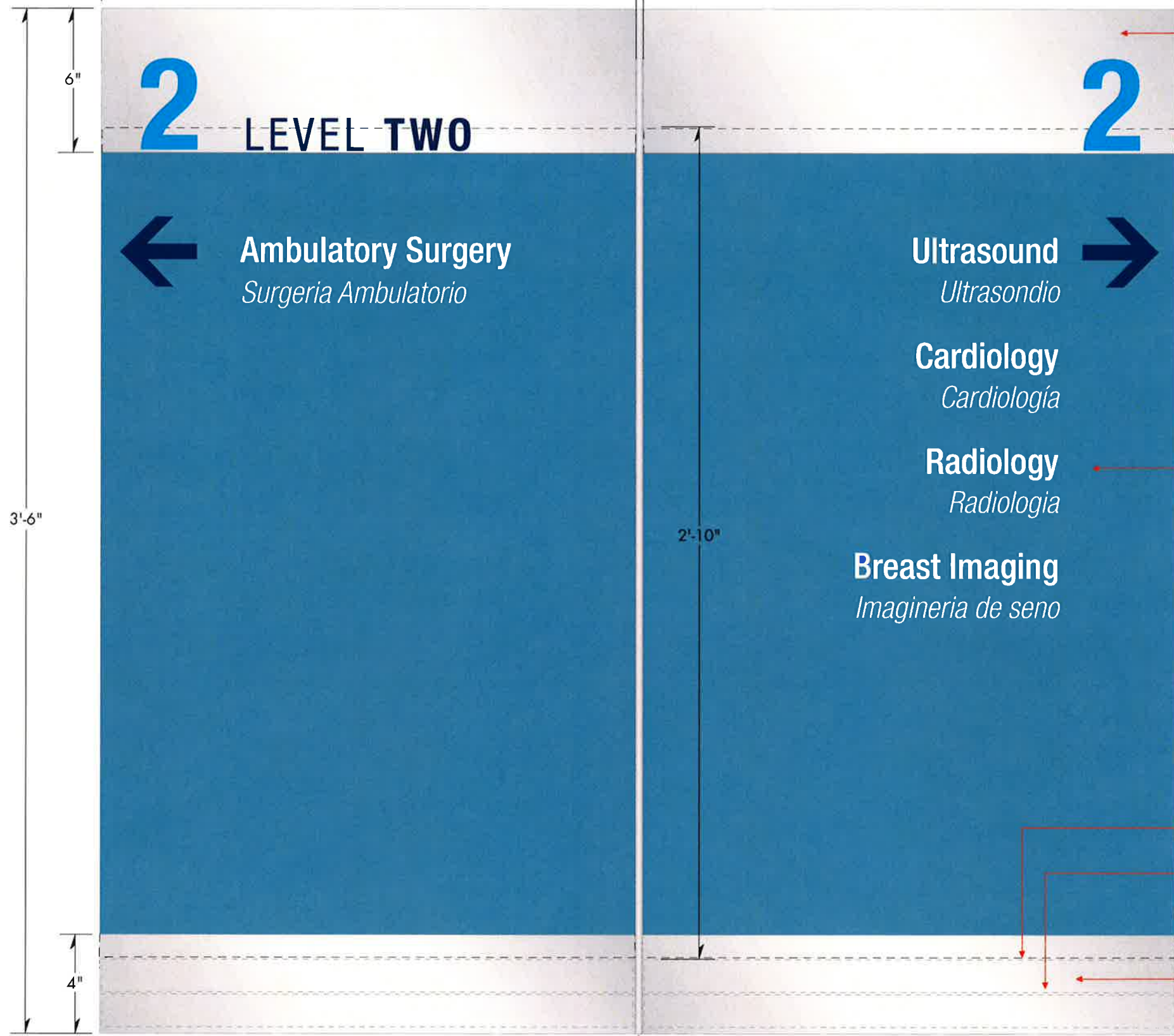

Upper Band
 3/16" "Satin Aluminum" MP#18071 accent band with "Dark Blue Metallic" 3M#220-217 & "Olympic Blue" 3M#220-57 vinyl graphics; Mounts to backer panel with 1/16" thick foamtape or equal to accept .060" Styrene® insert; 1/16" bevel on bottom edge of accent band. NOTE: Fabrication of armature/placement of band must be exact so all inserts fit precisely in armature. Fabricator is responsible for acquiring test prints and confirming sizes.

Insert extents of (dashed line)

Backer Panel
 1/8" painted "Satin Aluminum" MP#18071 backer panel inset 1/8" on both top and bottom

Changeable Graphics
 .060" Styrene® with printed graphics and anti-graffiti Laminate over printed graphic; NOTE: fabricator to confirm exact dimensions of insert = 1'-10" W x 2'-10" HT

Background color: **Pantone 549c**
 Printed graphics on substrate to match vinyl colors:
 White 3M#220-10
 Matte Blue 3M#220-407
 Olympic Blue 3M#220-57
 Dark Blue Metallic 3M#220-217

Insert extents of black (dashed line)

Tape extents of gray (dashed line)

Lower Band
 3/16" "Satin Aluminum" MP#18071 accent band with vinyl information graphics; Mounts to backer panel with 1/16" thick foamtape or equal to accept .060" Styrene® insert; 1/16" bevel on top edge of accent band. NOTE: Placement of band must be exact so insert fits precisely within armature.

Quantities:
 Refer to sign schedule/location plans

3'-6"

6"

2

LEVEL TWO

2



Ambulatory Surgery
 Surgeria Ambulatorio

Ultrasound
 Ultrasonido



Cardiology
 Cardiología

Radiology
 Radiología

Breast Imaging
 Imagineria de seno

2'-10"

2'-10"

4"

Divider Bar 1/4" square "Satin Aluminum" center bar MP#18071

D3 Directional single panel Level 6
 1 Scale: 1:5

Side View single panel Level 2
 Scale: 1:5

NOTE: NuHealth to review/confirm sign messages per final nomenclature matrix.
 All Spanish translations to be approved by owner.



INTERIOR SIGN SYSTEM NASSAU UNIVERSITY MEDICAL CENTER



ENVIRONMENTAL GRAPHICS
Gamble Design LLC
 154 Maplewood Avenue
 Portsmouth NH 03801
 ☎ 603.427.1300

INTERIOR DESIGN
TRO Jung | Brannen
 22 Boston Wharf Road
 Boston MA 02210
 ☎ 617.502.3400

DRAWING TITLE
Directional insert
 Wall mounted
 Scale: as shown
 20 August 2010

DRAWING N°

D2.1

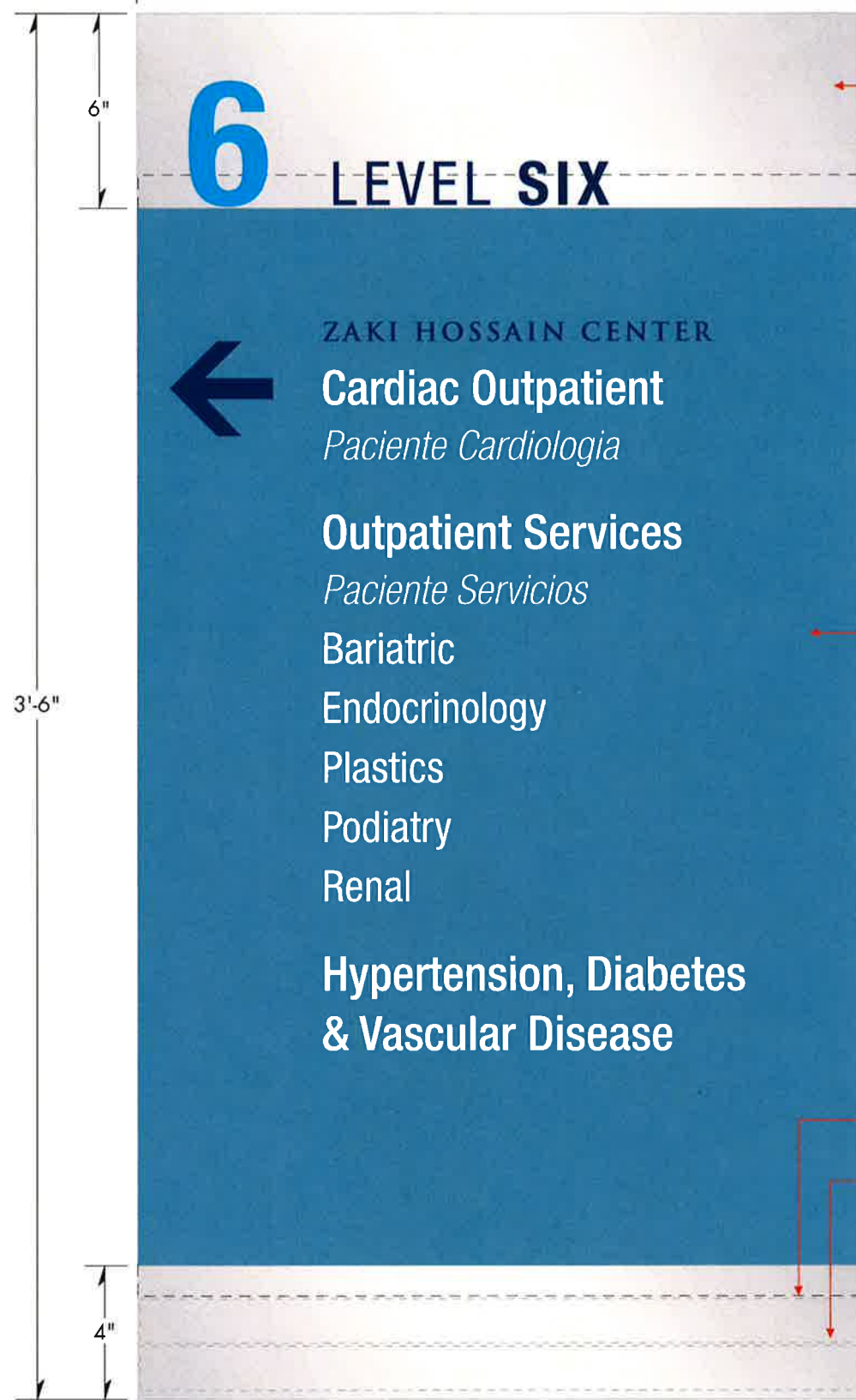

Upper Band

3/16" "Satin Aluminum" MP#18071 accent band with "Dark Blue Metallic" 3M#220-217 & "Olympic Blue" 3M#220-57 vinyl graphics; Mounts to backer panel with 1/16" thick foamtape or equal to accept 1/16" Styrene® insert; 1/16" bevel on bottom edge of accent band. NOTE: Fabrication of armature/ placement of band must be exact so all inserts fit precisely in armature. Fabricator is responsible for acquiring test prints and confirming sizes.

Insert extents of (dashed line)

Backer Panel

1/8" painted "Satin Aluminum" MP#18071 backer panel inset 1/8" on both top and bottom

Changeable Graphics

.060" Styrene® with printed graphics and anti-graffiti Laminate over printed graphic; NOTE: fabricator to confirm exact dimensions of insert = 1'-10" W x 2'-10" HT

Background color: **Pantone 549c**

Printed graphics on substrate to match vinyl colors:

White 3M#220-10

Matte Blue 3M#220-407

Olympic Blue 3M#220-57

Dark Blue Metallic 3M#220-217

Insert extents of black (dashed line)

Tape extents of gray (dashed line)

Lower Band

3/16" "Satin Aluminum" MP#18071 accent band with vinyl information graphics; Mounts to backer panel with 1/16" thick foamtape or equal to accept .060" Styrene® insert; 1/16" bevel on top edge of accent band. NOTE: Placement of band must be exact so insert fits precisely within armature.

Quantities:

Refer to sign schedule/location plans

2'-10"

D3 Directional single panel Level 6
1 Scale: 1:5

Side View single panel Level 6
Scale: 1:5

NOTE: NuHealth to review/confirm sign messages per final nomenclature matrix. All Spanish translations to be approved by owner.



INTERIOR SIGN SYSTEM NASSAU UNIVERSITY MEDICAL CENTER



ENVIRONMENTAL GRAPHICS
Gamble Design LLC
154 Maplewood Avenue
Portsmouth NH 03801
603.427.1300

INTERIOR DESIGN
TRO Jung|Brannen
22 Boston Wharf Road
Boston MA 02210
617.502.3400

DRAWING TITLE
Directional insert
Wall mounted
Scale: as shown
20 August 2010

DRAWING N°

D3.1

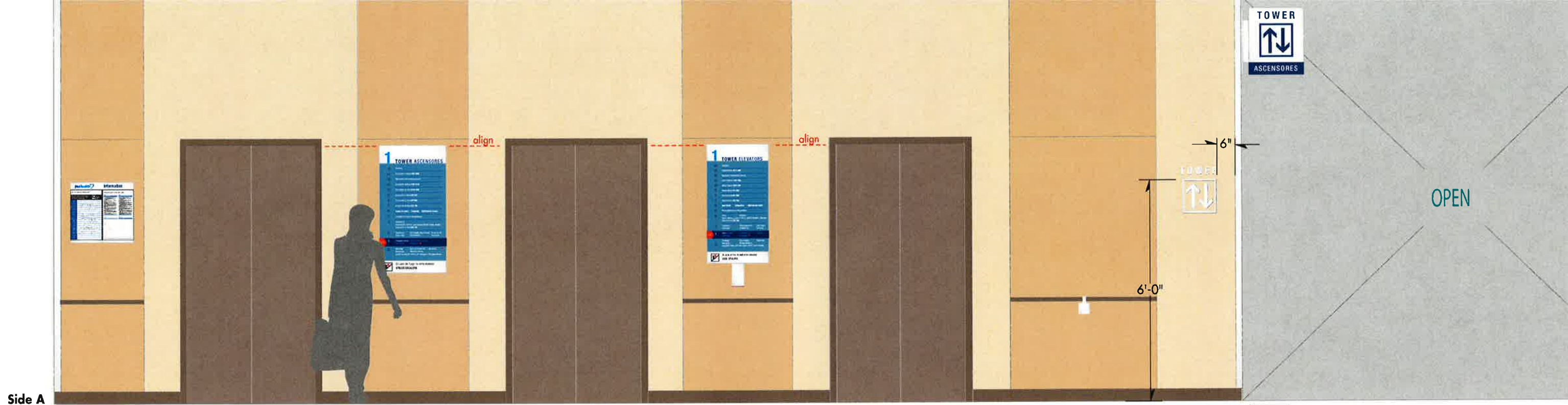

Side A
Sign Types **B3.1** **E3.1B** **E3.1A** **E2.1** **E1.1**

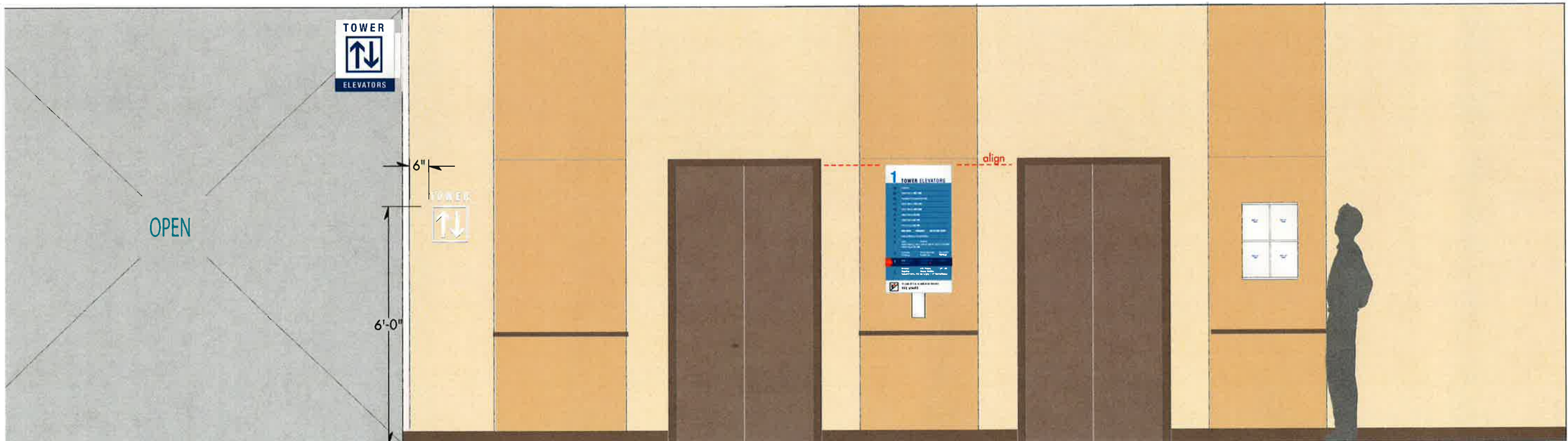

Sign Types **E1.1** **E2.1** **E3.1A** **B8.1** Side B

A Elevator Sign Placement wall mounted signs Level 1 - typical
Scale: 1/4" = 1'-0"

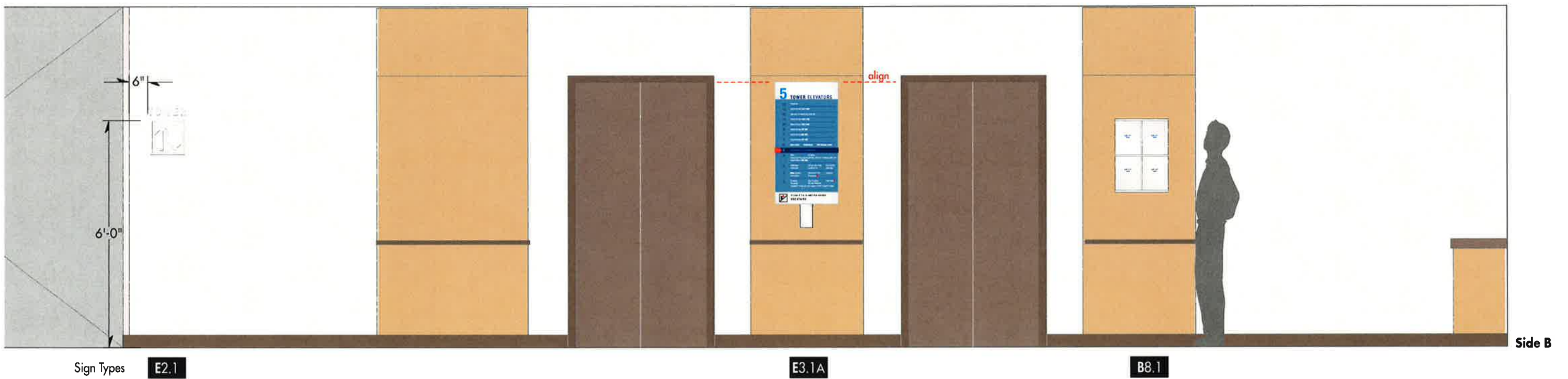

A Elevator Sign Placement wall mounted signs Level 5 - typical (Levels 2-19)
Scale: 1/4" = 1'-0"



INTERIOR SIGN SYSTEM NASSAU UNIVERSITY MEDICAL CENTER



ENVIRONMENTAL GRAPHICS
Gamble Design LLC
154 Maplewood Avenue
Portsmouth NH 03801
603.427.1300

INTERIOR DESIGN
TRO Jung|Brannen
22 Boston Wharf Road
Boston MA 02210
617.502.3400

DRAWING TITLE
Elevator Sign Placement
Elevator renovation Level 5
Scale: as shown
20 August 2010

DRAWING N°

E1.L5



Side View

E1 Primary Elevator ID

4" deep projecting sign assembly painted "Satin Aluminum" MP#18071 with "Deep Blue Metallic" MP#25373 accent band and 1/8" dimensional elevator graphics; "White" 3M#220-10 vinyl graphics in blue band. Assembly projects from brick walls at elevator lobby. Refer to E1.2 for details.

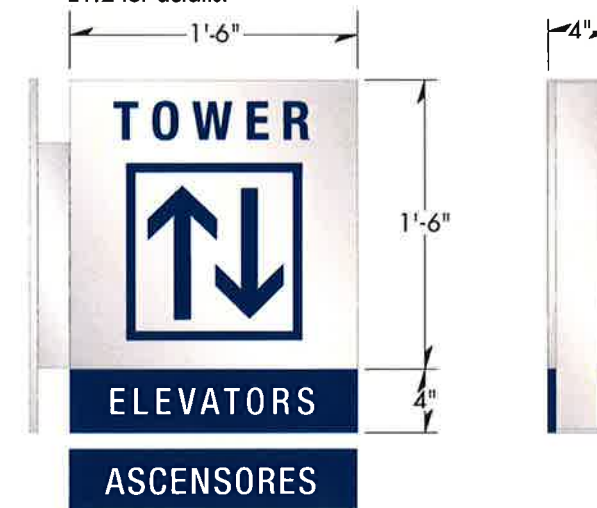

Qty : 2 (two)

E1 Primary Elevator ID Tower Elevator Level 1
 1 Scale: relative to image



INTERIOR SIGN SYSTEM NASSAU UNIVERSITY MEDICAL CENTER



ENVIRONMENTAL GRAPHICS
Gamble Design LLC
 154 Maplewood Avenue
 Portsmouth NH 03801
 ☎ 603.427.1300

INTERIOR DESIGN
TRO Jung|Brannen
 22 Boston Wharf Road
 Boston MA 02210
 ☎ 617.502.3400

DRAWING TITLE
Primary Elevator ID
 Projecting @ Level 1
 Scale: as shown
 20 August 2010

DRAWING N°

E1.1A



E1 Primary Elevator ID

4" deep projecting sign assembly painted "Satin Aluminum" MP#18071 with "Deep Blue Metallic" MP#25373 accent band and 1/8" dimensional elevator graphics; "White" 3M#220-10 vinyl graphics in blue band. Assembly projects from brick walls at elevator lobby. Refer to E1.2 for details.

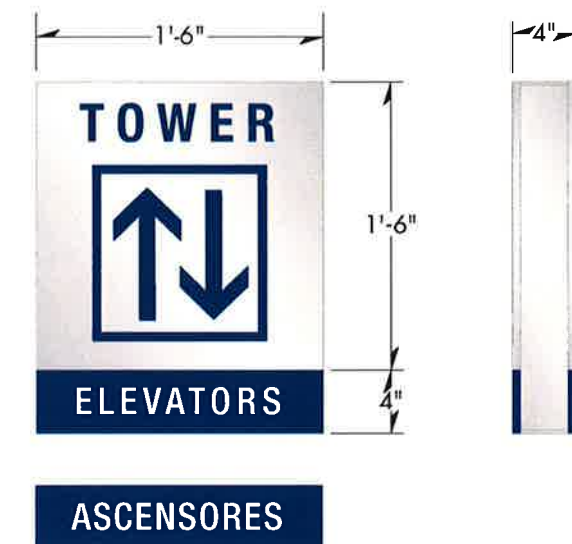

Qty: 2 (two)

E1 Primary Elevator ID Tower Elevator Level G
G Scale: relative to image

Primary Elevator ID Elevation
 Scale: 1" = 1'-0"



INTERIOR SIGN SYSTEM NASSAU UNIVERSITY MEDICAL CENTER



ENVIRONMENTAL GRAPHICS
Gamble Design LLC
 154 Maplewood Avenue
 Portsmouth NH 03801
 ☎ 603.427.1300

INTERIOR DESIGN
TRO Jung|Brannen
 22 Boston Wharf Road
 Boston MA 02210
 ☎ 617.502.3400

DRAWING TITLE
Primary Elevator ID
 Projecting @ Level G
 Scale: as shown
 20 August 2010

DRAWING N°

E1.GA

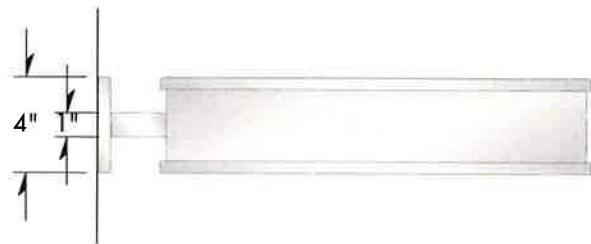

Plan View

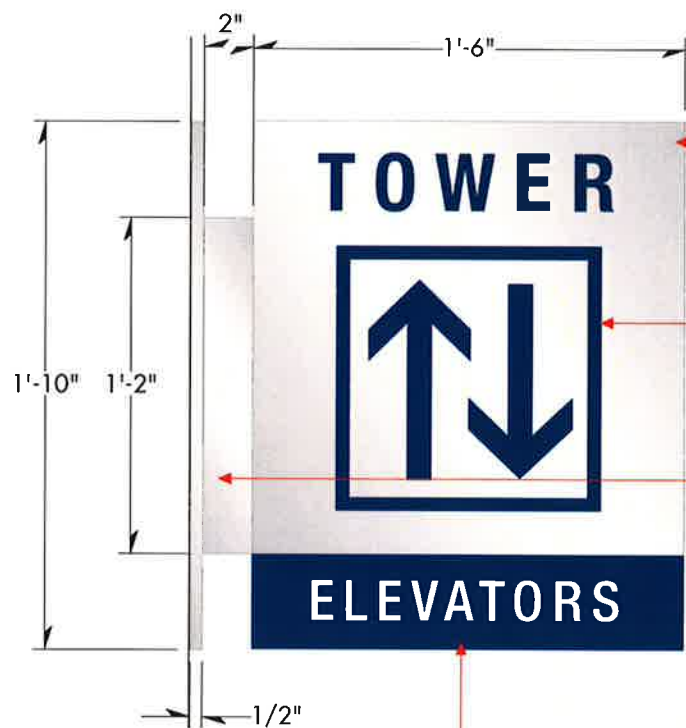

Sign Box

4" deep projecting sign box painted "Satin Aluminum" MP#18071 with 1/2" face panels and 3" recessed "Satin Aluminum" sign box.

Graphics

1/8" dimensional elevator graphics painted "Deep Blue Metallic" MP#25373

Mounting Armature

1" "Satin Aluminum" mounting armature projects from sign box with 1/2" thick mounting plate. Plate secures to wall with concealed or decorative fasteners. (Fabricator to detail connection in shop drawings.) Field verify all conditions.

Accent Band

4" painted accent band "Deep Blue Metallic" MP#25373 with vinyl graphics "White" 3M#220-10

Mounting

Sign assembly mounts as shown in drawings E1.1A & E1.GA. Inset sign assembly 2" from corner and 1 brick (level 1) or 2" (level G) from ceiling.

Qty : 2 (two)
1 @ Level 1 & 1 @ Level G

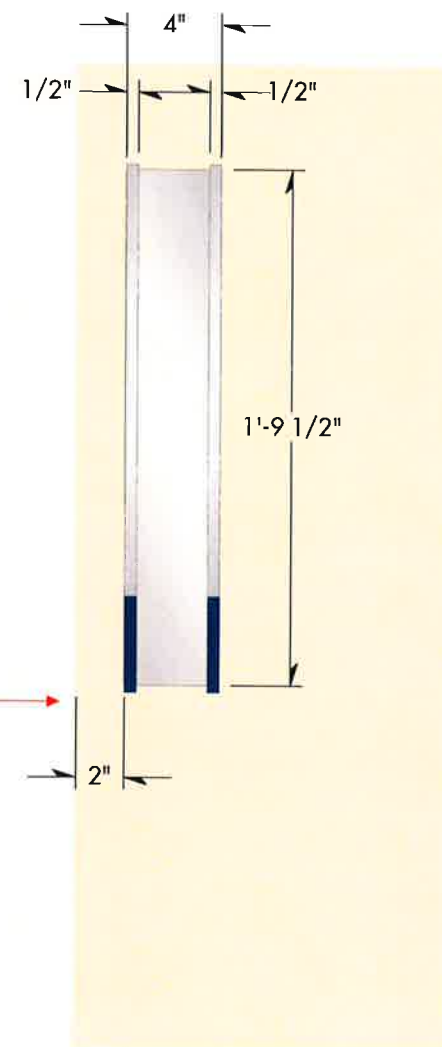

Side View

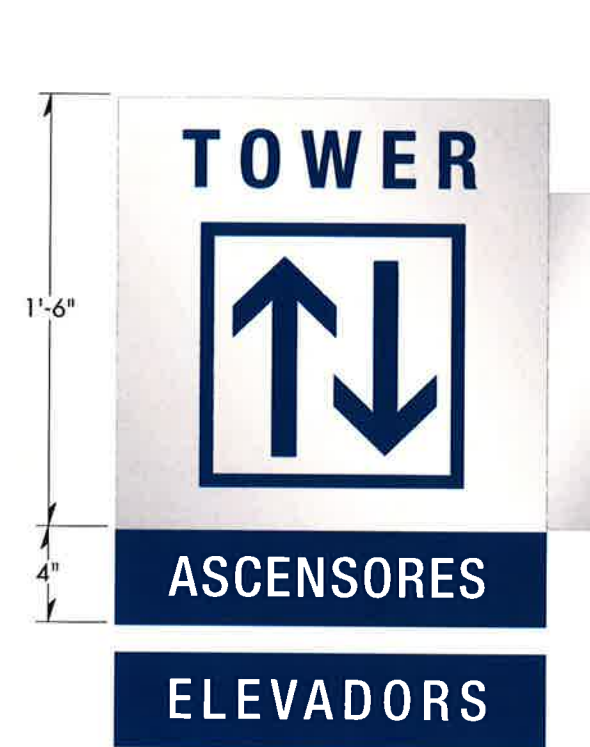

Qty : 2 (two)
1 @ Level 1 & 1 @ Level G

A Elevator ID English projecting
Scale: 1 1/2" = 1'-0"

B Elevator ID Spanish projecting
Scale: 1 1/2" = 1'-0"



INTERIOR SIGN SYSTEM NASSAU UNIVERSITY MEDICAL CENTER



ENVIRONMENTAL GRAPHICS
Gamble Design LLC
154 Maplewood Avenue
Portsmouth NH 03801
603.427.1300

INTERIOR DESIGN
TRO Jung|Brannen
22 Boston Wharf Road
Boston MA 02210
617.502.3400

DRAWING TITLE
Primary Elevator ID
Projecting panels
Scale: as shown
20 August 2010

DRAWING N°

E1.2

2 1/2" TOWER

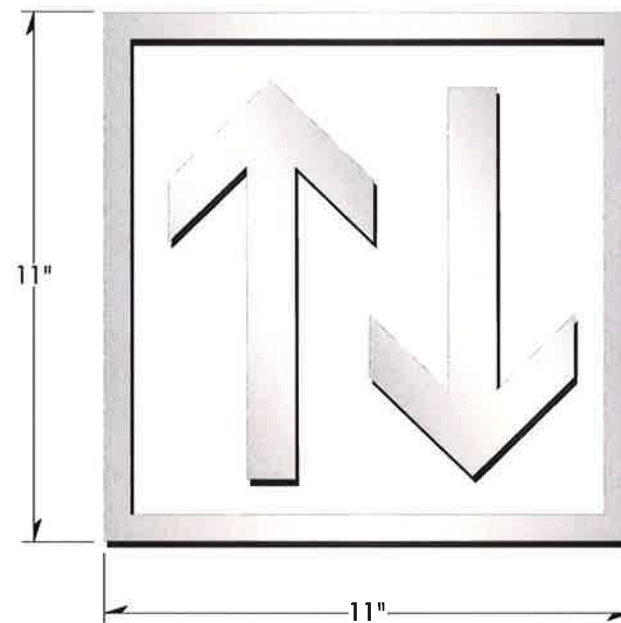

Graphics

1/2" dimensional "Satin Aluminum" MP#18071 graphics stud mounted flush to wall face at flanking corners of elevator lobbies. Refer to design drawings E1.1A & E1.GA for placement. Field verify all conditions.

Qty : 4 (four)

2 @ Level 1 & 2 @ Level G

A Secondary Elevator ID dimensional graphics wall mounted
Scale: 1 1/2" = 1'-0"



INTERIOR SIGN SYSTEM NASSAU UNIVERSITY MEDICAL CENTER



ENVIRONMENTAL GRAPHICS
Gamble Design LLC
154 Maplewood Avenue
Portsmouth NH 03801
603.427.1300

INTERIOR DESIGN
TRO Jung | Brannen
22 Boston Wharf Road
Boston MA 02210
617.502.3400

DRAWING TITLE
Secondary Elevator ID
Wall mounted
Scale: as shown
20 August 2010

DRAWING N°

E2.1

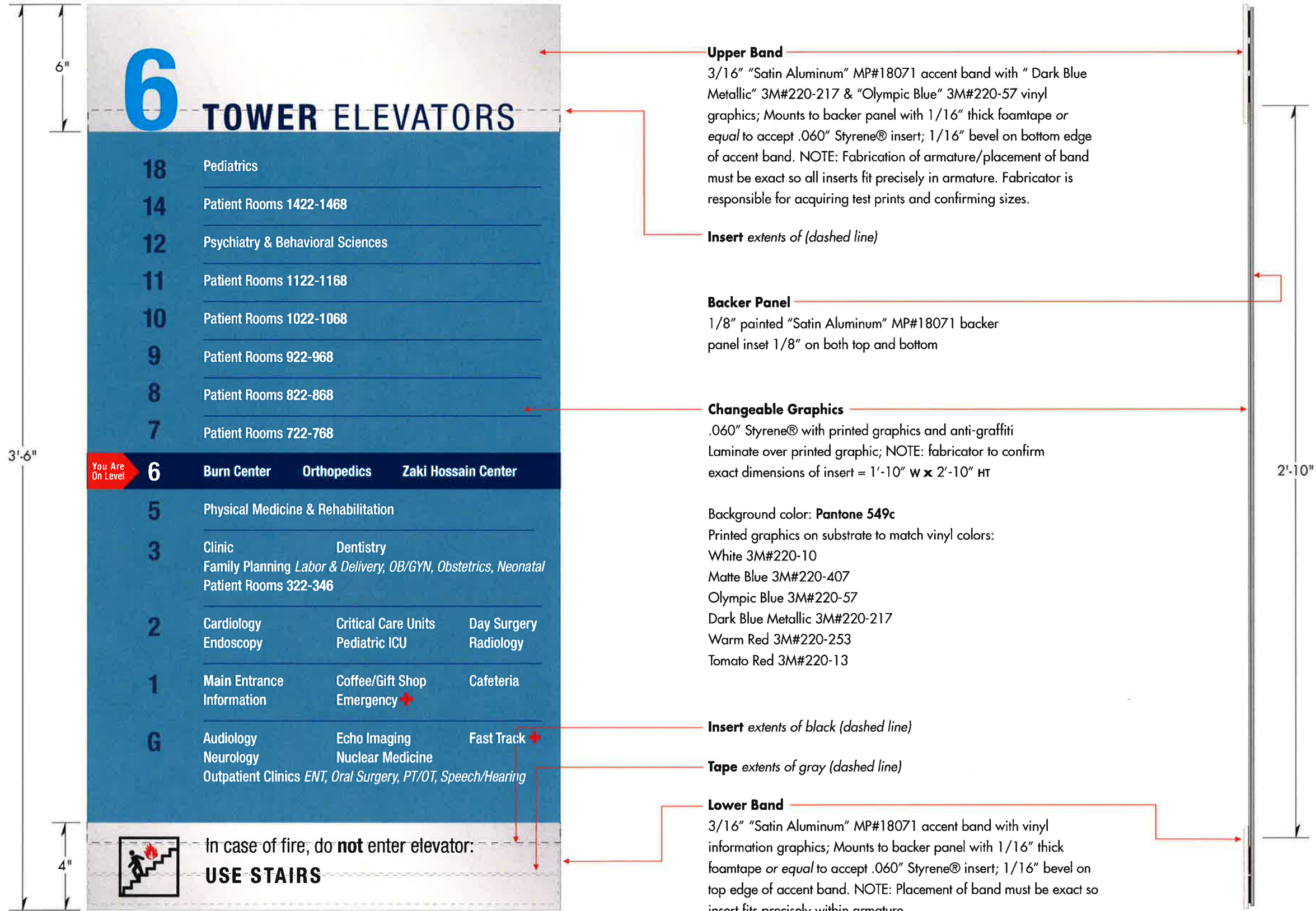

Upper Band
3/16" "Satin Aluminum" MP#18071 accent band with " Dark Blue Metallic" 3M#220-217 & "Olympic Blue" 3M#220-57 vinyl graphics; Mounts to backer panel with 1/16" thick foamtape or equal to accept .060" Styrene® insert; 1/16" bevel on bottom edge of accent band. NOTE: Fabrication of armature/placement of band must be exact so all inserts fit precisely in armature. Fabricator is responsible for acquiring test prints and confirming sizes.

Insert extents of (dashed line)

Backer Panel
1/8" painted "Satin Aluminum" MP#18071 backer panel inset 1/8" on both top and bottom

Changeable Graphics
.060" Styrene® with printed graphics and anti-graffiti laminate over printed graphic; NOTE: fabricator to confirm exact dimensions of insert = 1'-10" W x 2'-10" HT

Background color: **Pantone 549c**
Printed graphics on substrate to match vinyl colors:
White 3M#220-10
Matte Blue 3M#220-407
Olympic Blue 3M#220-57
Dark Blue Metallic 3M#220-217
Warm Red 3M#220-253
Tomato Red 3M#220-13

Insert extents of black (dashed line)

Tape extents of gray (dashed line)

Lower Band
3/16" "Satin Aluminum" MP#18071 accent band with vinyl information graphics; Mounts to backer panel with 1/16" thick foamtape or equal to accept .060" Styrene® insert; 1/16" bevel on top edge of accent band. NOTE: Placement of band must be exact so insert fits precisely within armature.

Quantities:
Tower Elevators : 2 (two) English/1 (one) Spanish each level
(for 19 levels = **57 (fifty-seven) total**)
A Elevator : 1 (one) English/ Levels G & 1 (= **2 (two) total**)
B Elevator : 1 (one) English/ Levels G & 1 (= **2 (two) total**)
Staff/Tower Elevators : 2 (two) English each level
(for 19 levels = **38 (thirty-eight) total**)
Staff/Emergency Elevators : 5 (five) total

Grand Total: 85 (eighty-five)

Insert Quantities (English):
Tower Elevators : 2 (two) English each level
(for 14 levels = **28 (twenty-eight) total**)
A Elevator : 1 (one) English/ Levels G & 1 (= **2 (two) total**)
B Elevator : 1 (one) English/ Levels G & 1 (= **2 (two) total**)
Staff/Tower Elevators : 2 (two) English each level
(for 14 levels = **28 (twenty-eight) total**)
Staff/Emergency Elevators : 5 (five) total

Grand Total: 65 (sixty-five)

E3
1 Elevator Directory single panel Level 6
Scale: 1:5

Side View single panel
Scale: 1:5

NOTE: NuHealth to review/confirm sign messages per final nomenclature matrix.
All Spanish translations to be approved by owner.

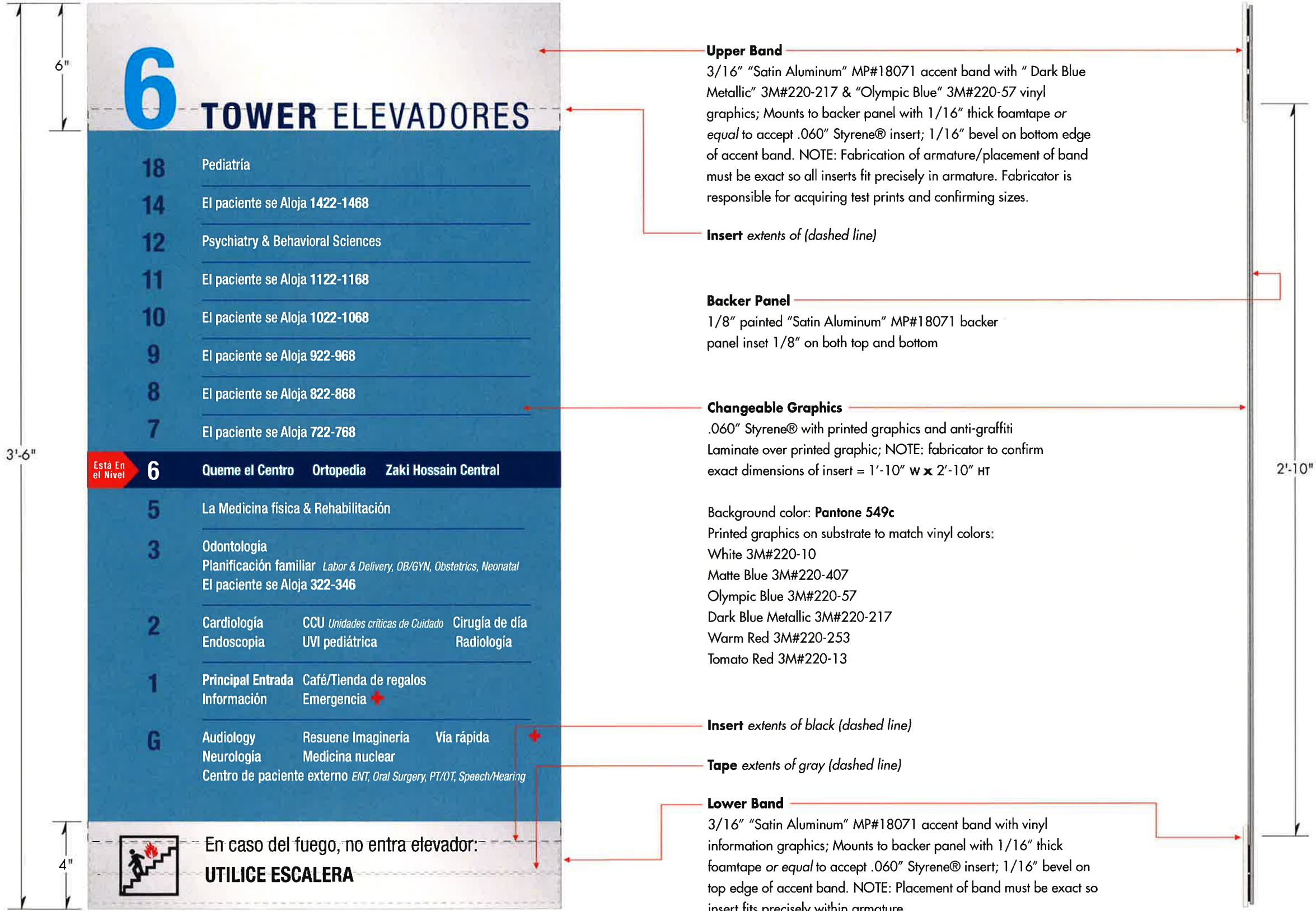

Armature Quantities:
Tower Elevators : 2 (two) English/1 (one) Spanish each level
 (for 19 levels = **57** (fifty-seven) total)
A Elevator : 1 (one) English/ Levels G & 1 (= **2** (two) total)
B Elevator : 1 (one) English/ Levels G & 1 (= **2** (two) total)
Staff/Tower Elevators : 2 (two) English each level
 (for 19 levels = **38** (thirty-eight) total)
Staff/Emergency Elevators : **5** (five) total

Grand Total: 85 (eighty-five)

Insert Quantities (Spanish):
Tower Elevators : 1 (one) Spanish each level (for 14 levels)
Grand Total: 14 (fourteen)

E3 Elevator Directory single panel Level 6
 1 Scale: 1:5

Side View single panel
 Scale: 1:5

NOTE: NuHealth to review/confirm sign messages per final nomenclature matrix.
 All Spanish translations to be approved by owner.

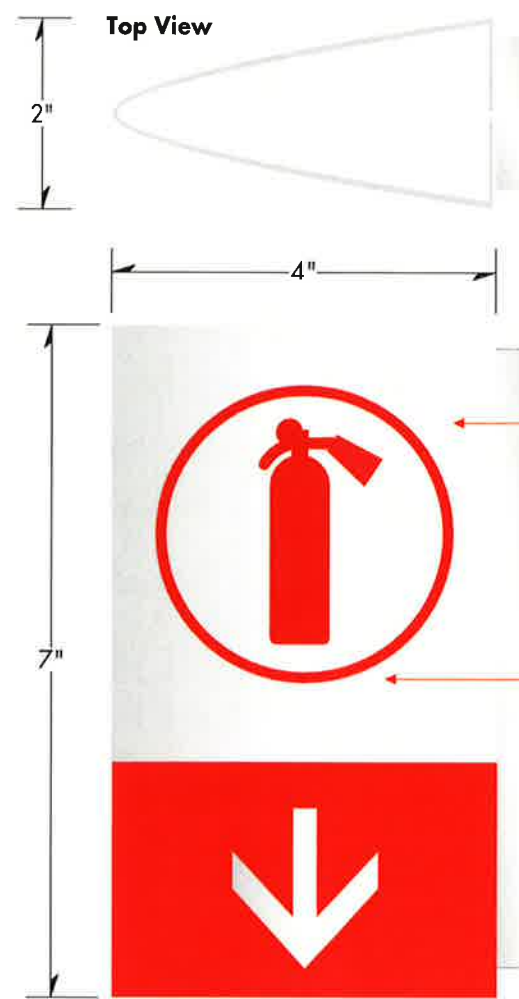

SPEC. NOTES:

Fabrication: Double-sided interior curved sign fabricated per notes shown. Fabricator can recommend option(s) for sign fabrication.

Installation: Sign armature projects from wall with hidden mechanical fasteners per interior architectural conditions.

Sign Panel

3/32" curved and break-formed satin aluminum panel mechanically fastened to mounting plate
color: "Satin Aluminum"
MP#18071

Sign Graphics

vinyl/screened graphics;
color: "Tomato Red" 3M #220-13
or
"Apple Green" 3M #220196

Mounting Plate

1/2" plate mounts armature to wall
color: "Satin Aluminum"
MP#18071

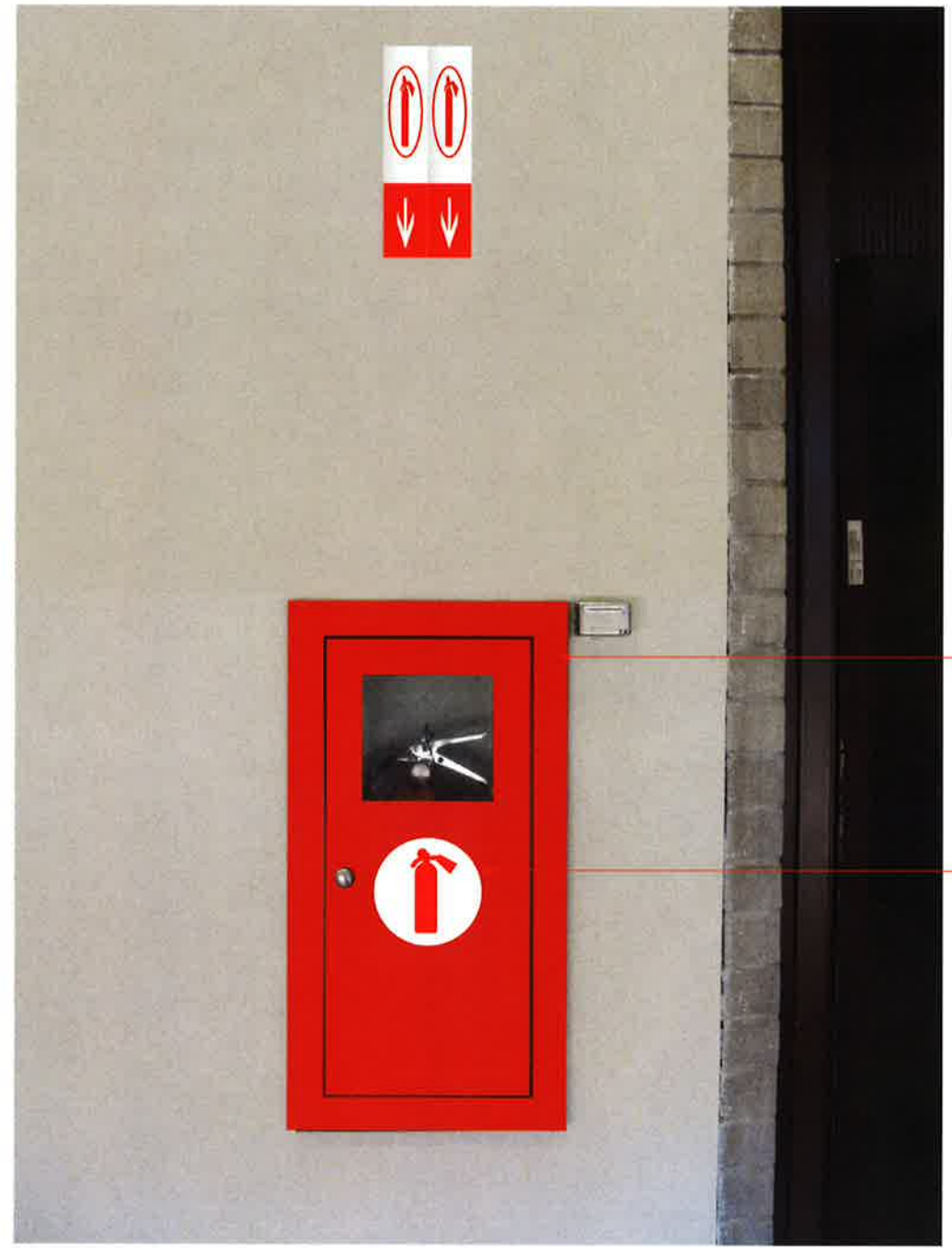

Existing Boxes

Repaint existing fire extinguisher boxes. Fabricator/Owner to coordinate.

Vinyl Graphics

3 1/2" circle, vinyl graphics applied to face of extinguisher box. "White" 3M#220-10 & "Tomato Red" 3M#220-13

A Fire Extinguisher ID F1-A projecting
Scale: 1:2 half actual size

End View

B Fire Extinguisher ID example
Scale: relative to image



Sign Panel

1/16" "Satin Aluminum" panel, MP#18071 with applied vinyl graphics.
 "Tomato Red" MP#220-13
 Locate as shown in image.

F5 Fire Door ID panel door mounted
 1 Scale: relative to image

A Fire Door ID panel door mounted
 Scale: 1:1 full size



INTERIOR SIGN SYSTEM NASSAU UNIVERSITY MEDICAL CENTER



ENVIRONMENTAL GRAPHICS
Gamble Design LLC
 154 Maplewood Avenue
 Portsmouth NH 03801
 ☎ 603.427.1300

INTERIOR DESIGN
TRO Jung | Brannen
 22 Boston Wharf Road
 Boston MA 02210
 ☎ 617.502.3400

DRAWING TITLE
Fire Door ID
 Door mounted
 Scale: as shown
 20 August 2010

DRAWING N°

F5.1

SYMBOLS *Standard Icons*



Hospital



Directional Arrow



Parking



No Parking



No Smoking



Emergency



Handicap Access



Elevator



Gift Shop



Café



Stairway



Information (International)



Fire Extinguisher



Restrooms:
Women/Men



Baby Changing
Station



Telephone



TTY/TDD Telephone



Information (DOT)



Hearing Assistance



Volume Control



ATM



Vending



Dining



No Food/Drink



No Entry/No Access



Exit/Access



AED
Automatic Emergency Defibrillator



Eye Wash



Radiation
Radioactive Materials

ABCDEFGHIJKLMNOPQRSTUVWXYZ
abcdefghijklmnopqrstuvwxyz
1234567890

1 **Typeface 1**
Helvetica Neue 55 Roman

ABCDEFGHIJKLMNOPQRSTUVWXYZ
abcdefghijklmnopqrstuvwxyz
1234567890

2 **Typeface 2**
Helvetica Neue 75 Bold

ABCDEFGHIJKLMNOPQRSTUVWXYZ
abcdefghijklmnopqrstuvwxyz
1234567890

3 **Typeface 3**
Helvetica Neue 76 Bold Italic

ABCDEFGHIJKLMNOPQRSTUVWXYZ
abcdefghijklmnopqrstuvwxyz
1234567890

4 **Typeface 4**
Helvetica Neue 57 Condensed

ABCDEFGHIJKLMNOPQRSTUVWXYZ
abcdefghijklmnopqrstuvwxyz
1234567890

5 **Typeface 5**
Helvetica Neue 57 Condensed Oblique

ABCDEFGHIJKLMNOPQRSTUVWXYZ
abcdefghijklmnopqrstuvwxyz
1234567890

6 **Typeface 3**
Helvetica Neue 77 Bold Condensed

ABCDEFGHIJKLMNOPQRSTUVWXYZ
abcdefghijklmnopqrstuvwxyz
1234567890

7 **Typeface 4**
Helvetica Neue 77 Bold Condensed Oblique

ABCDEFGHIJKLMNOPQRSTUVWXYZ
abcdefghijklmnopqrstuvwxyz
1234567890

8 **Typeface 5**
Helvetica Neue 87 Heavy Condensed

ABCDEFGHIJKLMNOPQRSTUVWXYZ
abcdefghijklmnopqrstuvwxyz
1234567890

9 **Typeface 9**
Adobe Garamond Regular

ABCDEFGHIJKLMNOPQRSTUVWXYZ
abcdefghijklmnopqrstuvwxyz
1234567890

10 **Typeface 10**
Adobe Garamond Semibold



















VINYL

Color Specifications

	Color	Vinyl #	Finish	Location	Remarks
V1	 "Dark Blue Metallic" "Dark Blue"	3M#220-217 3M#230-36	Metallic Translucent	Divider Bar @ logo	
V2	 "Olympic Blue"	3M#220-57 3M#230-57	Opaque Translucent	Logo "Health"	
V3	 "Matte Blue" "Delft Blue"	3M#220-407 3M#230-97	Opaque Translucent	Logo "Nu"	
V4	 "Tomoto Red" "Red"	3M#220-13 3M#230-33 3M#280-72	Opaque Translucent Reflective	Emergency letters/ symbol & Parking	
V5	 "White"	3M#220-10 3M#230-20	Opaque Translucent	D2.1 clearance	
V6	 "Light Blue" "Intense Blue"	3M#280-76 3M#230-127	Reflective Translucent	Parking, P symbol & Pedestrian Caution	
V7	 Black	3M#220-12	Opaque	Misc.	
V8	 "Apple Green"	MP#33653	Opaque	Door graphics	
V9	 "Sunflower"	3M#220-25	Opaque	Door graphics	
V10	 "Lemon Yellow"	3M#280-81	Reflective	Pedestrian Caution symbol	
V11	 "Bright Blue Metallic"	3M#220-227	Metallic	Door graphics	

PAINT

Color Specifications

	Color	Paint #	Finish	Location	Remarks
	 "Dark Blue Metallic" / "Indigo Blue Metallic"	MP#21992	Satin	ID + Directional	
	 "Satin Aluminum" / "Silverstone Metallic"	MP#18091	Satin	all signs	Replace MP#1871 with MP#18091
	 "Dark Gray Metallic" / "Smelted Steel Metallic"	MP#18243	Satin	1ID + 2ID skirt	Called medium gray in exterior package
	 "Red" / "Ruby Laser"	MP#03543	Satin	Emergency	
	 "Bright Orange" / "Kubota Orange"	MP#01049	Satin	D2.1 clearance	
	 "H Blue" / "Soda Can Blue"	MP#13912	Satin	Directional sign "H"	
	 "Black" / "Black Stallion"	MP#33653	Satin	No Smoking	
	 "Yellow" / "Yellow Shock"	MP#10240	Satin	Pedestrian Caution Cap	to match reflective "Lemon Yellow" vinyl 3M#280-81

